

PIAZZA

CATALOGO

CATALOGUE

2023

2024

LEGENDA CATALOGO

CATALOGUE KEY



Quando la singola confezione contiene più pezzi è presente questo simbolo
When the single pack contains more pieces there is this symbol

Beccuccio versatore "Versus"

"Versus" pouring spout

Cod.	Col.	Box
50100112		4
50100312		4
50100412		4
50100612		4



CONFEZIONAMENTO DEL PRODOTTO
PRODUCT PACKAGING

CODICE PRODOTTO
ITEM NUMBER

INFO PRODOTTO
Dimensioni, colore, capacità, ecc.
PRODUCT INFO
Sizes, colour, capacity, etc.

MULTIPLO DI VENDITA
Se non indicato si intende un pezzo singolo
BOX QUANTITY
If not stated just one piece

SIMBOLI CONFEZIONAMENTO PRODOTTI

PRODUCTS PACKAGING SYMBOLS



SCATOLA
BOX



SCATOLA APPENDIBILE
HANGING BOX



SACCHETTO
BAG



SACCHETTO APPENDIBILE
HANGING BAG



CARTONCINO APPENDIBILE
HANGING CARD



BLISTER SKINPACK



TERMORETRAIBILE
SHRINK WRAP



VARIABLE
VARIABLE

SIMBOLI UTILIZZO PENTOLAME

POTS AND PANS SYMBOLS



GAS



VETROCERAMICA
CERAMIC



ELETTRICO
HOTPLATES



INDUZIONE
INDUCTION

I MATERIALI

THE MATERIALS



Acciaio inox	Stainless steel	Stahl	Inox	Inox
Alluminio	Aluminum	Aluminium	Aluminium	Aluminio
Alluminio anodizzato	Anodized aluminum	Aluminium anodisiert	Alu anodisé	Aluminio anodizado
Alluminio oxalizzato	Oxalized aluminum	Aluminium eloxiert	Alu éloxé	Aluminio oxalizado
Alluminio antiaderente	Non-stick aluminum	Aluminium mit Antihaftbeschichtung	Aluminium antiadhésif	Aluminio antiaderente
Alluminio pressofuso	Die-cast aluminum	Druckgussaluminium	Aluminium moulé sous pression	Aluminio fundido bajo presión
Banda stagnata	White latten	Blech	Fer étamé	Banda estañada
Caucciù	Rubber	Kautschuk	Caoutchouc naturel	Caucho
Ceramica	Ceramic	Ton	Céramique	Cerámica
Cotone	Cotton	Baumwolle	Coton	Algodón
Ferro Bianco	White Iron	Weiss eisen	Fer blanc	Hierro blanco
Ferro Blu	Blue steel	Blau Blech	Fer bleu	Hierro azul
Fibra di vetro	Fiberglass	Fiberglas	Fibre de verre	Fibra de vidrio
Gomma	Rubber	Gummi	Caoutchouc	Goma
Latta	Tin	Blech	Fer Blanc	Hojalata
Legno	Wood	Holz	Bois	Madera
Melamina	Melamin	Melamin	Mélamine	Melamina
Ottone	Brass	Messing	Laiton	Latón
Pelle ovina	Kid leather	Olivinleder	Cuir de boeuf	Piel ovina
Plastica	Plastic	Plastik	Plastique	Plástico
Poliammide	Polyamide	Polyamid	Polyamide	Poliamida
Policarbonato	Polycarbonate	Polikarbonat	Polycarbonate	Policarbonato
Polietilene	Polyethylene	Polyäthlen	Polyéthlene	Polietileno
Polipropilene	Polypropylene	Polypropylen	Pollypropylène	Polipropileno
Porcellana	Porcelain	Porzellan	Porcelaine	Porcelana
Propilene	Propylene	Propylen	Propylène	Propileno
Rame	Copper	Kupfer	Cuivre	Cobre
Resina	Resin	Harz	Résine	Resina
Silicone	Silicone	Silikon	Silicone	Silicona
Vetro	Glass	Glás	Verre	Vidrio

PIAZZA

CATALOGO

CATALOGUE

2023

2024

UNA STORIA DI QUALITÀ E DI ATTACCAMENTO AL NOSTRO TERRITORIO

HISTORY OF QUALITY AND CONNECTION
WITH OUR LAND



**NASCE IL NUOVO
STABILIMENTO
SULLO STESSO LUOGO
DEL VECCHIO E INIZIA
LA SPECIALIZZAZIONE
NEL SETTORE HO.RE.CA.**

THE NEW PLANT IS BUILT
ON THE SAME SITE
OF THE OLD ONE AND
IT STARTS FOCUSING
ON PROFESSIONAL
KITCHEN TOOLS

1970

**GIANNI PIAZZA
BREVETTA IL PRIMO
PORZIONATORE
IN ACCIAIO INOX.
È SOLO UNO DEI TANTI
BREVETTI DI QUEGLI ANNI**

GIANNI PIAZZA
PATENTS THE FIRST
ICE-CREAM SCOOP MADE
OF STAINLESS STEEL.
IT'S JUST ONE OF
THE MANY PATENTS
OF THOSE YEARS

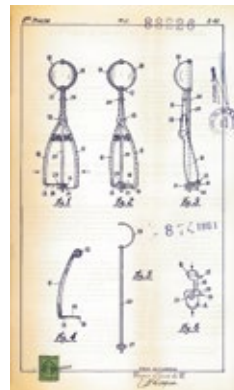

1961



**I FRATELLI GIUSEPPE
E BALDASSARRE PIAZZA
FONDANO L'AZIENDA**

THE COMPANY WAS FOUNDED
BY THE BROTHERS GIUSEPPE
AND BALDASSARRE PIAZZA



1906

**DOPO POCHI ANNI
DI VITA PIAZZA
È GIÀ ATTIVA
SUI PRIMI MERCATI
DELL'ERA MODERNA**

AFTER A FEW YEARS
PIAZZA IS ALREADY
ACTIVE ON THE FIRST
MARKETS OF THE
MODERN ERA

1930

**COMINCIA
IL PASSAGGIO
DA LABORATORIO
FAMILIARE
A MODERNA
INDUSTRIA**

THE TRANSITION
FROM FAMILY
WORKSHOP
TO MODERN
MANUFACTURING
COMPANY BEGINS



ANCHE IL SECONDO STABILIMENTO DIVENTA OPERATIVO

ALSO THE SECOND PLANT GETS OPERATIONAL



2004



IL LANCIO DELLA LINEA "HAPPY HOUR" RIVOLUZIONA IL MONDO DEL BARTENDING. DAL 2006 AL 2021 PIAZZA DIVENTA SPONSOR TECNICO DI ALMA, LA SCUOLA INTERNAZIONALE DI CUCINA ITALIANA

THE LAUNCH OF THE 'HAPPY HOUR' LINE TRANSFORMS THE WORLD OF BARTENDING. FROM 2006 TO 2021 PIAZZA BECOMES TECHNICAL SPONSOR OF ALMA, THE SCHOOL OF ITALIAN CULINARY ARTS

2021



NASCE LA NUOVA COLLEZIONE PIZZERIA "PUNTOROSSO", 100% MADE IN ITALY

THE NEW PIZZERIA RANGE IS LAUNCHED ON THE MARKET. 'PUNTOROSSO' COLLECTION: 100% MADE IN ITALY

IL SITO WEB VIENE TOTALMENTE RINNOVATO

THE WEBSITE IS TOTALLY RENEWED



2023

1990

OGGI PIAZZA È UN'AZIENDA PRONTA AD AFFRONTARE LE SFIDE DI UN MERCATO IN RAPIDA E COSTANTE EVOLUZIONE

TODAY PIAZZA IS A COMPANY READY TO FACE THE CHALLENGES OF A RAPIDLY AND CONSTANTLY EVOLVING MARKET

2 SEDI PRODUTTIVE
MANUFACTURING UNITS

13.500 M² DI SUPERFICIE TOTALE
OF TOTAL SURFACE

200 M² IL NOSTRO PUNTO VENDITA
OUR STORE & OUTLET

7 AGENTI IN ITALIA
AGENTS IN ITALY

360 DISTRIBUTORI IN ITALIA
DISTRIBUTORS IN ITALY

5 AGENTI NEL MONDO
AGENTS WORLDWIDE

150 DISTRIBUTORI NEL MONDO
DISTRIBUTORS WORLDWIDE

+50 I PAESI NEL MONDO IN CUI VENDIAMO
COUNTRIES WHERE WE OPERATE



INVENTIAMO, PROGETTIAMO, PRODUCIAMO. SEMPRE QUI, DOVE SIAMO NATI!

WE INVENT, WE DESIGN, WE MANUFACTURE.
ALWAYS HERE, WHERE WE WERE BORN!

1

ASCOLTIAMO I PROFESSIONISTI, NE INTERPRETIAMO LE NECESSITÀ E CERCHIAMO DI CAPIRE LE LORO ESIGENZE

WE LISTEN TO PROFESSIONALS, INTERPRET THEIR REQUESTS AND TRY TO FULFILL THEIR NEEDS

2

TRADUCIAMO SUGGERIMENTI E CONSIGLI IN UN'IDEA DI PRODOTTO, IN GRADO DI SODDISFARE LE ASPETTATIVE DI CHI LO USERÀ

WE TURN TIPS AND ADVICES INTO A PRODUCT IDEA, THAT CAN MEET USERS' EXPECTATIONS

3

I DESIGNER CHE PROGETTANO PER PIAZZA DANNO FORMA ALLA NOSTRA IDEA TRADUCENDOLA IN UN PRODOTTO REALE

THE DESIGNERS WHO WORK FOR PIAZZA GIVE SHAPE TO OUR IDEA RESULTING IN A PROJECT

4

CON LA STAMPA 3D VIENE REALIZZATO UN PROTOTIPO IN MISURA REALE, SUL QUALE SI FANNO LE PRIME VERIFICHE RELATIVE A FORMA E FUNZIONALITÀ

WE CREATE A REAL SIZE PROTOTYPE, WITH 3D PRINTING, TO MAKE THE FIRST CHECKS ON SHAPE AND FUNCTIONALITY

5

IL NOSTRO UFFICIO RICERCA E SVILUPPO INGEGNERIZZA IL PRODOTTO E REALIZZA I DISEGNI DEFINITIVI PER LA CREAZIONE DEGLI STAMPI

R&D DEPARTMENT ENGINEERS THE PRODUCT AND CREATES THE FINAL DRAWINGS TO MAKE THE MOLDS

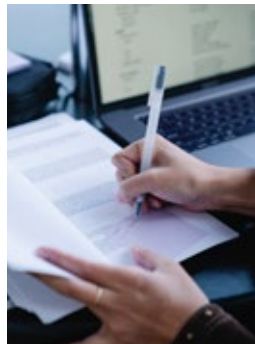

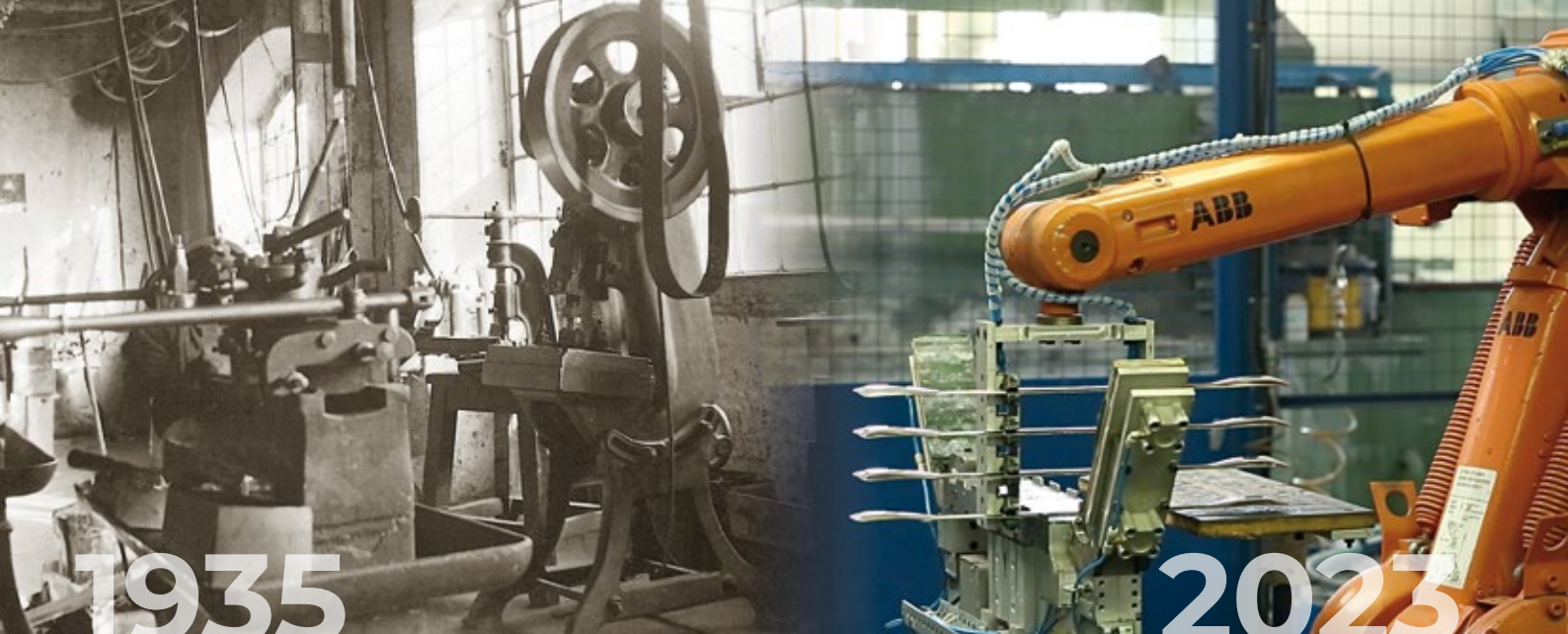

6

VENGONO FATTI GLI STAMPI CHE SERVIRANNO PER LA PRODUZIONE DEFINITIVA

WE MAKE THE MOLDS FOR THE FINAL PRODUCTION

7

PRIMA DI ESSERE MESSO IN COMMERCIO IL PRODOTTO VIENE ACCURATAMENTE TESTATO PER ESSERE CERTI DELLA SUA QUALITÀ

BEFORE BEING PUT ON THE MARKET, THE PRODUCT IS CAREFULLY TESTED TO BE SURE OF ITS QUALITY

8

IL PRODOTTO FINITO VIENE "VESTITO" CON IL PACKAGING E IMMESSO SUL MERCATO

THE FINISHED PRODUCT IS 'FINALIZED' WITH THE PACKAGING AND FINALLY LAUNCHED ON THE MARKET

9

SI RACCOLGONO I FEEDBACK, SIA POSITIVI CHE NEGATIVI, IN MERITO AL PRODOTTO E A TUTTE LE SUE CARATTERISTICHE

WE COLLECT THE FEEDBACK, BOTH POSITIVE AND NEGATIVE, REGARDING THE PRODUCT AND ALL ITS CHARACTERISTICS

10

CONTINUIAMO A LAVORARE SUL PRODOTTO PER MIGLIORARLO, PERFEZIONARLO E RENDERLO SEMPRE PIÙ VICINO AI BISOGNI DI CHI LO UTILIZZA

WE CONTINUE TO WORK ON THE PRODUCT TO IMPROVE IT, PERFECT IT AND MAKE IT CLOSER TO USERS' NEEDS

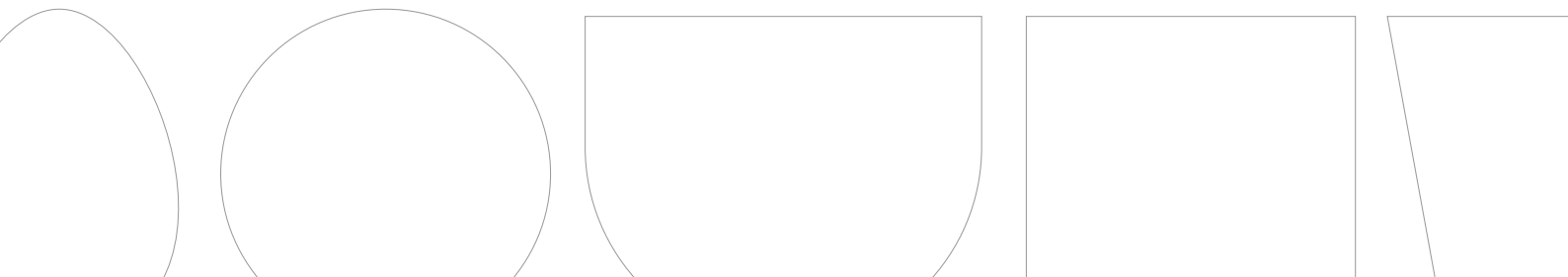

CON VOI OVUNQUE VOGLIATE, PER FARVI SENTIRE SEMPRE IN BUONE MANI.

WITH YOU WHEREVER YOU WANT,
TO MAKE YOU ALWAYS FEEL IN BUONE MANI*

Grazie alla nuova veste del nostro sito web www.piazza.it potete consultare, in qualunque momento e dovunque voi siate, l'intero nostro catalogo.

L'abbiamo pensato per rendere la vostra ricerca facile e veloce, secondo quell'idea di massima funzionalità che è il tratto caratteristico di tutti i nostri prodotti.

Inoltre, grazie ai nostri canali social, resterete sempre aggiornati in tempo reale su novità ed eventi.

Thanks to the new look of our website www.piazza.it you can browse our entire catalog everytime and everywhere.

Its design allows a quick and easy search. Being functional is the central idea for both our communication tools and products.

Moreover, thanks to our social channels, you will always have real-time updates on news and events.

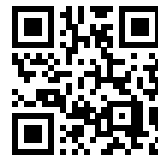
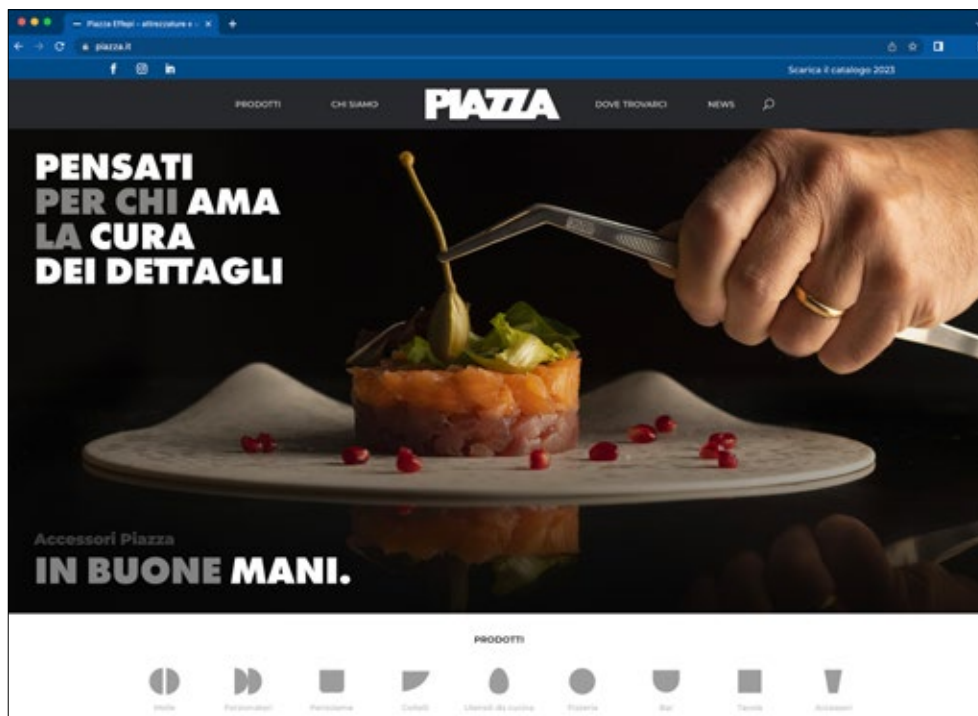

**INQUADRA
IL QR CODE
E SCOPRI IL
NOSTRO SITO**
SCAN THE
QR CODE
AND DISCOVER
OUR WEBSITE



* The expression 'in buone mani' (translatable as 'in good hands') is a common Italian saying to reassure and make you feel sure about the quality, reliability, safety of a product or service

DESIDERATE UN PRODOTTO PERSONALIZZATO? LO POSSIAMO FARE!

DO YOU WISH A PERSONALIZED PRODUCT?
WE CAN DO IT!

Siamo, da sempre, un'azienda di produzione attenta ai bisogni dei propri clienti.

È per questo che vogliamo offrire loro la possibilità di personalizzazione dei nostri prodotti con il logo o altri elementi. Anche il packaging, in base ai quantitativi, può essere personalizzato con la grafica fornita dal cliente.

Possiamo farlo in tempi rapidi e con la massima versatilità, grazie all'esperienza e alla passione delle persone che lavorano in PIAZZA.

Per saperne di più: piazza@piazza.it

We have always been a manufacturing company who cares about the needs of its customers.

That's why we want to offer them too the possibility of personalizing our products with their logo or other elements.

Even the packaging, based on the quantities, can be customized with graphics supplied by the customer.

We can do it quickly and with maximum versatility, thanks to experience and passion of the people who work in PIAZZA.

To know more: piazza@piazza.it



COLLABORARE CON I PROFESSIONISTI, IL NOSTRO "INGREDIENTE" PER MIGLIORARCI DI CONTINUO

COOPERATE WITH PROFESSIONALS,
OUR 'INGREDIENT' TO CONTINUOUSLY IMPROVE

Amiamo raccontare i nostri prodotti attraverso le mani sapienti dei migliori professionisti, accompagnandoli nei loro gesti quotidiani.

Il dialogo, l'ascolto e la collaborazione con loro fanno parte del nostro DNA aziendale. Ci offrono la loro esperienza per testare i nostri prodotti, valutandone praticità e resistenza, al fine di trovare le migliori soluzioni.

Siamo quindi felici che si rinnovi, anche quest'anno, la collaborazione decennale tra PIAZZA e Marco Sacco, nato e diventato famoso sulle sponde del lago di Mergozzo.

Marco è presente sul nostro territorio con due ristoranti: Piccolo Lago a Mergozzo (2 stelle Michelin) e Il Verbano sull'Isola dei Pescatori, oltre che a Torino con Piano 35 (1 stella Michelin). Da anni porta, inoltre, avanti il progetto "Gente di Lago e di Fiume", volto a valorizzare l'ecosistema delle acque interne lacustri e fluviali.

We love describing our products through the expert hands of the best professionals, supporting them in their daily gestures.

Communication, listening and cooperation with professionals are part of our corporate DNA. They offer us their experience to test our products, evaluating their practicality and resistance, in order to find the best solutions.

We are therefore happy to renew the ten-year collaboration between PIAZZA and Marco Sacco, born and became famous on the shores of Lake Mergozzo.

Marco is active in our area with two restaurants: Piccolo Lago in Mergozzo (2 Michelin stars) and Il Verbano on the Isola dei Pescatori, as well as in Turin with Piano 35 (1 Michelin star).

For years he has also been carrying on the project 'People of the lake and the river', aimed at enhancing the ecosystem of inland lake and river waters.



piccolo lago

MICHELIN
2023

RESTAURANT
PIANO
35
MICHELIN
2023

IL VERBANO
DI MARCO SACCO

IDENTITÀ GOLOSE

Nasce nel gennaio del 2004 dall'idea di Paolo Marchi di dar vita al primo congresso italiano di cucina e pasticceria d'autore. **PIAZZA ha creduto da subito a questo progetto e da allora ne è sponsor tecnico, fornendo le attrezzature alle cucine durante le varie fasi delle manifestazioni.**

Born in January 2004 from a Paolo Marchi's idea: set up the first Italian congress of signature cuisine and pastry. Right from the beginning, **PIAZZA** trusted this project and since then it has been a technical sponsor, providing kitchen equipments and accessories during events and demonstrations.



AIBES

L'Associazione Italiana Barmen e Sostenitori riunisce ogni anno i professionisti e le aziende che operano nel mondo del bar, guidati dalla volontà di sostenere e tutelare la professione del barman. La storia di AIBES si intreccia con quella di PIAZZA poiché entrambi accomunati dall'impegno nel sostenere il mondo del bar in tutte le sue sfaccettature: mixology, flair e caffetteria.

A.I.B.E.S., Italian Barmen and Sponsor Association, gathers professionals and companies both working in bartending world and yearning to support and protect the profession of barman. A.I.B.E.S. and **PIAZZA** both share a commitment to support all sides of the world of bartending: mixology, flair and coffee bar.



CHIC

CHIC, Charming Italian Chef, nata nel 2009 è un'associazione che raggruppa professionisti eterogenei di alto profilo: chef, pizzaioli, pasticciere, gelatieri, e panettieri. Un punto d'incontro dove i migliori rappresentanti della tradizione ed innovazione della cucina italiana si incontrano con le migliori aziende del settore HoReCa per dare vita ad una cucina sostenibile e di qualità.

CHIC, Charming Italian Chef, founded in 2009 is an association that gathers an heterogeneous group of high-level professionals: chefs, pizza chefs, pastry chefs, ice cream makers and bakers. A reference point where the best representatives of Italian cuisine tradition and innovation meet best HoReCa companies to promote a sustainable and high-quality cuisine.



G-PIZZA

Cinque chef italiani si sono uniti nel 2018 per fondare G-Pizza, un'associazione che propone eventi e corsi di formazione per pizzaioli, panificatori e pasticciere. La collaborazione tra PIAZZA e i professionisti dell'arte bianca nasce dal desiderio di dare risalto al mondo della pizzeria, valorizzando le materie prime e gli strumenti utilizzati.

Five Italian chefs founded G-Pizza World Food Agency in 2018. G-Pizza is an association that offers events and training courses for pizza makers, bakers and pastry chefs. The cooperation between **PIAZZA** and these professionals stems from the desire to emphasize the world of pizza, enhancing ingredients and accessories.



I NOSTRI PARTNER SUL TERRITORIO
THE PARTNERS IN OUR AREA





ACCESSORI

ACCESSORIES

MOLLE
TONGS

12

PINZE
SCISSOR SERVERS

18

PORZIONATORI GELATO
ICE-CREAM SCOOPS

20

SPATOLE E BACINELLE GELATO
ICE-CREAM SERVERS AND CONTAINERS

22

TAPPI VERSATORI
POURERS

24

COLINI
MESH STRAINERS

30



Molla per servire

Serving tongs	Cod.	L cm	Box
	010000	23	12



Molla per ghiaccio

Ice cube tongs	Cod.	L cm	Box
	010400	18	12



Molla per servire

Serving tongs	Cod.	L cm	Box
	010100	23	12



Molla per zucchero

Sugar tongs	Cod.	L cm	Box
	010500	12,5	12



Molla per pane a conchiglia

Bread tongs	Cod.	L cm	Box
	010200	26	12
	010223	23	12



Molla per dolci

Pastry tongs	Cod.	L cm	Box
	010600	18	12



Molla per spaghetti

Spaghetti tongs	Cod.	L cm	Box
	010300	23,5	12
	010326	26	12



**SCOPRI LA QUALITÀ
100% MADE IN ITALY**
DISCOVER THE QUALITY
100% MADE IN ITALY



MOLLE PIAZZA: SEMPLICEMENTE INDISPENSABILI
 PIAZZA TONGS: SIMPLY INDISPENSABLE

Le molle PIAZZA sono da sempre punto di riferimento per il mercato, sia per il design che per l'effettiva superiorità di un prodotto immancabile nella collezione di ogni professionista.

I dettagli risaltano l'unicità di ogni singola molla: la curvatura di alcune applicazioni, quale la molla spaghetti, come invito per raccogliere meglio gli alimenti, il molleggio che conferisce sempre la stessa maneggevolezza anche dopo un numero infinito di pressioni, grazie ad un accorgimento produttivo esclusivo e ancora oggi riservato, come le formule che resistono da anni a ogni tentativo di imitazione. Proprio questa sicurezza permette solo a PIAZZA di garantire l'inalterabilità delle proprie molle.

PIAZZA's tongs have always been the collection used as reference point for the market, both for design and for the effective superiority of a product that is a must for every professional's collection.

Lastly, the details highlight the uniqueness of each individual pair: the curvature of certain applications, such as the spaghetti tongs, which is like an invitation to gather up the food in the best way; or the spring which always gives the same manoeuvrability even after an infinite number of pressing, this thanks to an exclusive production device which is still secret today, as are the formulas which for years have resisted all attempts of imitation.

Precisely this certainty permits PIAZZA alone to guarantee the inalterability of its tongs.

LE "MOLLUNGHE"
 PIAZZA 'MOLLUNGHE'

Quattro pezzi speciali che grazie al loro esclusivo e caratteristico design, più lungo delle normali molle, daranno un'impronta raffinata al vostro buffet.

Four perfect items that, thanks to their unique and distinctive design, give an impression of great elegance for your buffet table.



Mollunga per spaghetti Design by Michele Capuani

Buffet spaghetti tongs 'Mollunga'	Cod.	L cm	Box
	010700	30	12



Mollunga per servire Design by Michele Capuani

Buffet tongs 'Mollunga'	Cod.	L cm	Box
	010800	30	12



Mollunga per carne e verdure Design by Michele Capuani

Buffet meat tongs 'Mollunga'	Cod.	L cm	Box
	010900	30	12



Mollunga per toast e dolci Design by Michele Capuani

Buffet toast tongs 'Mollunga'	Cod.	L cm	Box
	011000	30	12





Molla per ghiaccio

Ice cube tongs

Cod.	L cm	Box
011100	20	12



Molla per lumache a filo

Wire snail tongs

Cod.	L cm	Box
011700	15,5	12



Molla per zucchero

Sugar tongs

Cod.	L cm	Box
011200	11	12



Molla per spaghetti

Spaghetti tongs

Cod.	L cm	Box
011800	19,5	12



Molla per zucchero

Sugar tongs

Cod.	L cm	Box
011300	14	12



Molla per dolci

Pastry tongs

Cod.	L cm	Box
011900	16,5	12



Molla per asparagi individuale

Individual asparagus tongs

Cod.	L cm	Box
011400	13	12



Molla per asparagi

Asparagus tongs

Cod.	L cm	Box
012000	19	12



Molla per ghiaccio

Ice cube tongs

Cod.	L cm	Box
011500	16	12



Molla per insalata

Salad tongs

Cod.	L cm	Box
012100	19,5	12



Molla per lumache

Snail tongs

Cod.	L cm	Box
011600	16	12



Molla per vegetali

Vegetables tongs

Cod.	L cm	Box
012200	19,5	12





Molla per servire

Serving tongs	Cod.	L cm	Box
	012300	19,5	12



Molla per carne e vegetali

Serving tongs	Cod.	L cm	Box
	012700	21	12



Molla per spaghetti

Spaghetti tongs	Cod.	L cm	Box
	012400	20,5	12



Pinza per servire

Serving tongs	Cod.	L cm	Box
	012800	24	12



Molla per toast e dolci

Toast tongs	Cod.	L cm	Box
	012500	21	12



Molla per affettati

Sliced ham tongs	Cod.	Box
	012900	12



Molla per asparagi

Asparagus tongs	Cod.	L cm	Box
	012600	20	12



Molla per barbecue

Barbecue tongs	Cod.	L cm
	014000	50





Molla di precisione per cucina

Design by Michele Capuani

Precision kitchen tongs	Cod.	L cm	Box
	014500	30	12
	014515	15	12
	014523	23,5	12
	014540	40	12



Molla universale per cucina

Design by Michele Capuani

All-in-one kitchen tongs	Cod.	L cm	Box
	015000	30	12
	015012	12	12
	015018	18	12
	015023	23,5	12



Molla di precisione 40° per cucina

Design by Michele Capuani

40° precision kitchen tongs	Cod.	L cm	Box
	014600	30	12
	014615	15	12
	014623	23,5	12



Molla fonda per cucina

Design by Michele Capuani

Curved kitchen tongs	Cod.	L cm	Box
	015500	30	12
	015518	18	12
	015523	23,5	12



**LE MOLLE TEST E KAIMAN:
PENSATE DA LUCIANO TONA
E CONCRETIZZATE DAL DESIGN
DI MICHELE CAPUANI**

THE TEST AND KAIMAN TONGS:
AN ORIGINAL IDEA
BY LUCIANO TONA,
DESIGNED BY MICHELE CAPUANI



Molla Test

Design by Michele Capuani

Test tongs	Cod.	L cm	Box
	014100	13,5	12



Molla Kaiman

Design by Michele Capuani

Kaiman tongs	Cod.	L cm	Box
	014200	18	12



Un oggetto indispensabile per i professionisti della ristorazione grazie alla capacità di racchiudere in 13,5 cm molteplici funzioni.

- CUCCHIAINO PER L'ASSAGGIO DELLE PREPARAZIONI
- PINZA DALLA PRECISIONE CHIRURGICA
- MISURINO GRADUATO (0,5 CM)

A new tool measuring just 13.5 cm that's bound to become indispensable for all catering professionals as it offers so many different functions.

- SPOON FOR TASTING FOOD
- TONGS FOR ASSEMBLING PREPARATIONS WITH SURGICAL PRECISION
- SCALED MEASURE (0.5 CM)



La Molla Kaiman affianca la Test, ampliando la vasta gamma delle molle cucina PIAZZA.

Progettata per la lavorazione del pesce.

- BECCUCCI DELISCATRICI DI PRECISIONE
- TACCHE POSTERIORI PER RIFINIRE LA SQUAMATURA
- SPECIALE ZIGRINATURA ANTISCIVOLO PER UNA PRESA SEMPRE SICURA

The Kaiman tongs is added to the popular Test tongs, extending the wide range of PIAZZA kitchen tongs. Specifically designed for fish.

- PRECISION FISH BONE REMOVERS
- REAR NOTCHES FOR PERFECT FISH SCALING
- NON-SLIP RIDGES FOR A SECURE GRIP





Molla nylon

Nylon tongs	Cod.	L cm	Col.	Box
	018601	23	●	12
	018607	23	●	12
	018701	30,4	●	12
	018707	30,4	●	12



Molla universale nylon

Design by Michele Capuani

Nylon all-in-one tongs	Cod.	L cm	Box
	018600	23	12
	018700	30	12



SBLOCCO FACILE
EASY RELEASE



MOLLA A SCOMPARSA
DROP SPRING



Molla universale nylon & fiberglass

Design by Michele Capuani

Nylon & fiberglass all-in-one tongs	Cod.	L cm	Box
	01822302	23	12
	01823002	30	12
	01824002	40	12



Molla di precisione nylon & fiberglass

Design by Michele Capuani

Nylon & fiberglass precision tongs	Cod.	L cm	Box
	01833000	30	12



Molla toast nylon

Design by Michele Capuani

Nylon toast tongs	Cod.	L cm	Box
	01813000	30	12



THE SPECIAL MIX
NYLON & FIBERGLASS

Le nuove molle **PIAZZA** nate interamente in Italia. Lo speciale polimero con cui vengono prodotte: una combinazione di nylon e fibra di vetro, garantisce praticità d'uso e durata nel tempo.

- RESISTENTI AL CALORE FINO A 220°C
- L'ASSENZA DI SALDATURE GARANTISCE MASSIMA IGIENE
- LAVABILI IN LAVASTOVIGLIE

PIAZZA new tongs are fully made in Italy. They are made of a special polymer, a combination of nylon and fiberglass, that gives great guarantee of lasting in time and ease of use.

- HEAT RESISTANT UP TO 220°C (430°F)
- THE ABSENCE OF WELDINGS GUARANTEES MAXIMUM HYGIENE
- DISHWASHER SAFE

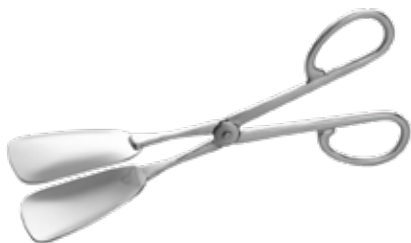

**Pinza per dolci forgiata**

Pastry scissor server

Cod.	L cm
020000	18,5

**Pinza per dolci forgiata**

Pastry scissor server

Cod.	L cm
020300	21
0203001	21



Cod. 0203001

**Pinza per dolci forgiata**

Pastry scissor server

Cod.	L cm
020100	20

**Pinza per torta forgiata**

Pie scissor server

Cod.	L cm
020400	25

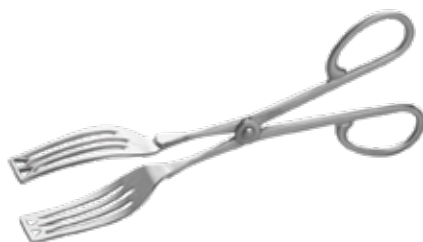
**Pinza per dolci forgiata**

Pastry scissor server

Cod.	L cm
020200	20
0202001	20



Cod. 0202001

**Pinza per antipasti forgiata**

Hors-d'ouvres scissor server

Cod.	L cm
020500	19

**NATE PER SFIDARE IL TEMPO**
BORN TO BE TIMELESS

Le pinze sono uno degli articoli storici della produzione Piazza. Alcune di loro sono diventate dei "classici" tanto da essere presenti in catalogo sin dai primi anni '60 con lo stesso design di quelle odierne, a testimonianza di un'attenzione particolare nei confronti della funzionalità dei nostri prodotti, una caratteristica che ci contraddistingue da sempre. Ancora oggi, come allora, vengono interamente prodotte in Italia, ponendo la massima cura nella loro realizzazione e nel loro assemblaggio in modo da renderle pressoché indistruttibili. La disponibilità infine di pezzi particolari, quali le pinze "Mignon", rende la gamma Piazza una delle più complete sul mercato.



Pinza per antipasti forgiata

Hors-d'ouvres scissor server Cod. L cm
020600 19



Pinza per toast forgiata

Toast scissor server Cod. L cm
020900 19



Pinza per dolci "Mignon" forgiata

Midget scissor server 'Mignon' Cod. L cm
020700 15



Pinza per insalata forgiata

Salad scissor server Cod. L cm
021000 24

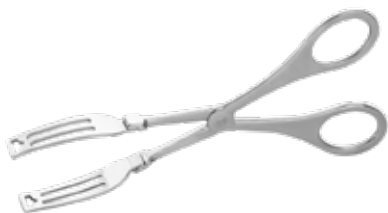

Pinza per dolci "Mignon" forgiata

Midget scissor server 'Mignon' Cod. L cm
020800 15



Pinza per forno

Hot plate holder Cod. L cm
021100 18,5



Scissor servers are one of Piazza's classic products. Indeed, some of these have appeared in our catalogue since the early 1960s, with the same design today. This proves just how valuable is the great attention we pay to the functionality of our products, a characteristic that has always distinguished us. Today, as in the past, these products are made entirely in Italy. We pay the utmost attention to their production and assembly to make them virtually indestructible. Finally, the availability of specific items, such as the "Mignon" scissor servers, means that the Piazza range is one of the most comprehensive on the market today.

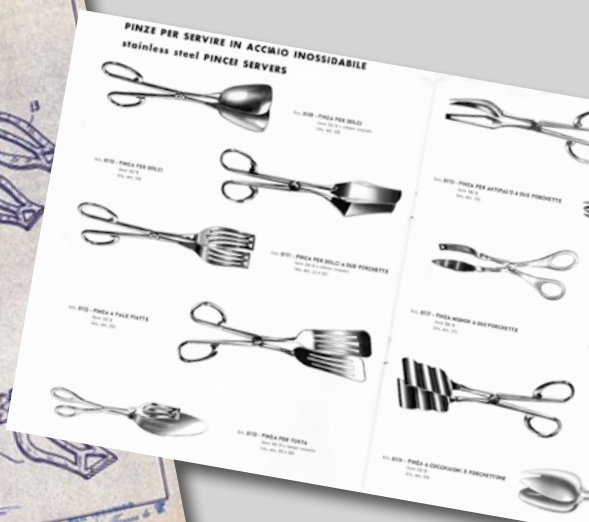
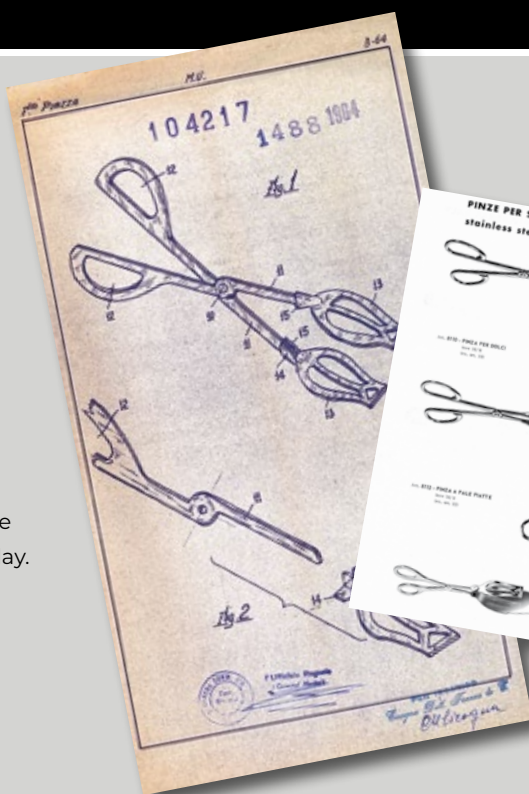

L'ABBIAMO INVENTATO NOI!
WE INVENTED IT!

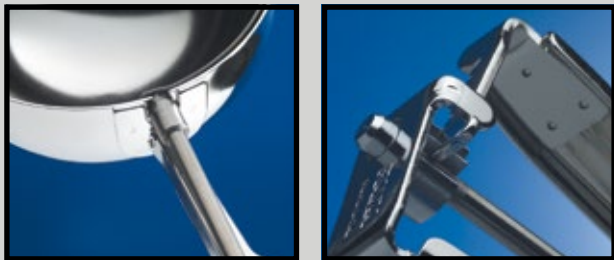

I porzionatori costituiscono, nell'assortimento PIAZZA, un'azienda nell'azienda. Il fattore determinante è l'idea, infatti, il brevetto originale di questo prodotto appartiene a PIAZZA e risale agli anni '60.

Da allora è "Il Porzionatore", che, rinnovato costantemente, rappresenta oggi il riferimento qualitativo del settore, con soluzioni tecniche impareggiabili, quali

- SALDATURE ED ACCOPPIAMENTI AL LIMITE DELL'IMPOSSIBILE
- UN DISEGNO ERGONOMICO PERFETTO
- UN MECCANISMO INDISTRUTTIBILE CHE SOPPORTA STRESS DA UTILIZZO PRESSOCHÉ INFINITI
- ASSORTIMENTO VASTISSIMO (13 DIVERSE CAPACITÀ)

In the PIAZZA assortment, ice cream scoops constitute a company within a company. The determining factor is the idea. In fact the original patent for this product belongs to PIAZZA and dates back to the 60's.

Since then the 'Porzionatore', constantly renewed, represents the sector qualitative reference today, with unparalleled technical solutions such as

- WELDS AND COUPLINGS TO THE LIMITS OF THE HIGH IMPOSSIBLE
- PERFECT ERGONOMIC DESIGN
- AN INDESTRUCTIBLE MECHANISM WHICH CAN TOLERATE ALMOST INFINITE USER STRESS
- WIDE ASSORTMENT (13 DIFFERENT CAPACITIES).

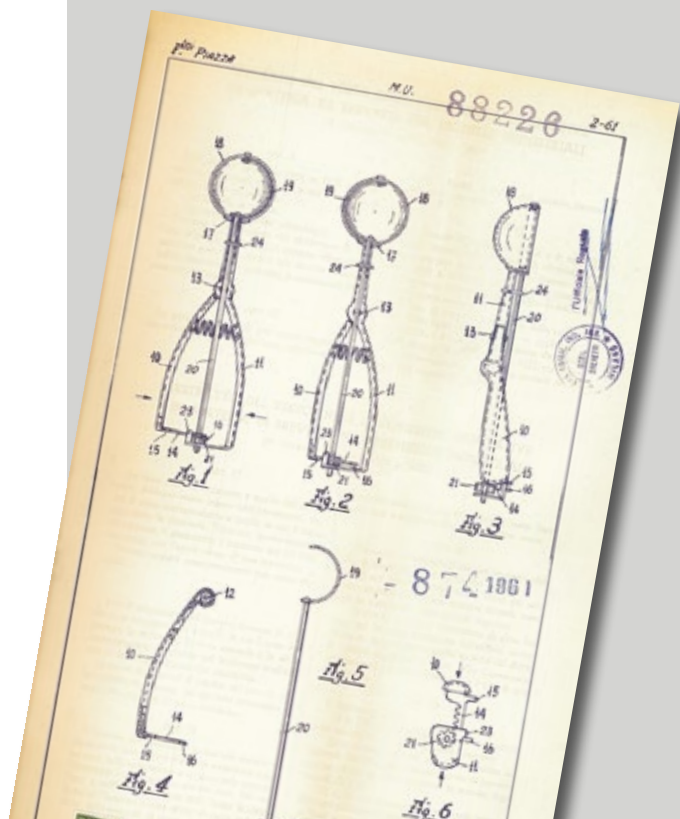

Porzionatore neoclassico

Ice-cream scoop	Cod.	Ø cm	Cap.	Box
	030008	7,8	1/8 Lt	4
	030010	7,5	1/10 Lt	4
	030012	7	1/12 Lt	4
	030016	6,3	1/16 Lt	4
	030020	6	1/20 Lt	6
	030024	5,5	1/24 Lt	6
	030030	5,2	1/30 Lt	6
	030036	4,9	1/36 Lt	6
	030040	4,7	1/40 Lt	6
	030050	4,3	1/50 Lt	6
	030060	4	1/60 Lt	6
	030070	3,7	1/70 Lt	6
	030099	3,3	1/100 Lt	6



CARATTERISTICHE TECNICHE

- Interamente in acciaio inox 18/10
- Composti da 12 particolari perfettamente assemblati con saldature a proiezione ad alta tecnologia
- Adatti al lavaggio in lavastoviglie
- Elettrolucidati con metodi alimentari nel rispetto delle norme ambientali
- Cremagliera con spessore di 2 mm per offrire una maggiore scorrevolezza
- Presenza di una bussolina di tenuta per impedire l'uscita dell'astina
- Scorrimento completo dell'astina sulla coppa per creare cerchi perfetti
- Testati per oltre un milione di palline

AVVERTENZE E CONSIGLI D'USO

- Per garantire un rendimento ottimale del porzionatore il gelato non dovrebbe avere una temperatura inferiore ai -5°C
- Si raccomanda di tenere il porzionatore sotto acqua corrente tiepida, ciò contribuisce a impedire la formazione di batteri e ne aumenta la scorrevolezza durante l'uso

TECHNICAL DATA

- Made from 100% 18/10 st. steel
- 12 perfectly assembled components with hi-tech projection welding
- Dishwasher suitable
- Electropolished with feed methods compliant with environmental regulations
- 2 mm-thick rack for better smoothness
- A bush to prevent the rod from coming out
- Full movement of the rod within the cup to create perfect circles
- Tested by producing more than a million balls of ice-cream

WARNING AND HINTS

- To guarantee top efficiency of the ice-cream scoop, the ice-cream shouldn't be colder than -5°C
- We recommend placing the scoop under warm running water before use to avoid the formation of bacteria and to allow it to slide better during use



Porzionatore ovale

Oval ice-cream scoop	Cod.	L cm	Cap.	Box
	030130	4,5 x 6	1/30 Lt	6



NUOVO PORZIONATORE

NEW ICE-CREAM SCOOP

LIGHT & STRONG



Porzionatore bianco con astina colorata

Ice-cream scoop, white
with coloured steel bar

Design by Michele Capuani

Cod.	Ø cm	Cap.	Col.	Box
03522401	5,3	1/24 Lt	●	6
03522402	5,3	1/24 Lt	○	6
03522403	5,3	1/24 Lt	●	6
03522404	5,3	1/24 Lt	●	6
03522406	5,3	1/24 Lt	●	6
03522407	5,3	1/24 Lt	●	6
03523001	5	1/30 Lt	●	6
03523002	5	1/30 Lt	○	6
03523003	5	1/30 Lt	●	6
03523004	5	1/30 Lt	●	6
03523006	5	1/30 Lt	●	6
03523007	5	1/30 Lt	●	6
03523601	4,7	1/36 Lt	●	6
03523602	4,7	1/36 Lt	○	6
03523603	4,7	1/36 Lt	●	6
03523604	4,7	1/36 Lt	●	6
03523606	4,7	1/36 Lt	●	6
03523607	4,7	1/36 Lt	●	6
03524001	4,5	1/40 Lt	●	6
03524002	4,5	1/40 Lt	○	6
03524003	4,5	1/40 Lt	●	6
03524004	4,5	1/40 Lt	●	6
03524006	4,5	1/40 Lt	●	6
03524007	4,5	1/40 Lt	●	6

Il nuovo porzionatore Piazza nasce dalla ricerca e dallo sviluppo del nostro ufficio tecnico e trova forme e colori freschi e accattivanti grazie alla matita di Michele Capuani. Un piccolo, grande concentrato di tecnologia e design, 100% Made in Italy, capace di offrirvi prestazioni ineguagliabili, in gelateria come in cucina.

The new Piazza ice-cream scoop is the result of the research and development of our engineering office, while Michele Capuani designed fresh and attractive shapes and colors. A small, yet a great extract of technology and design, fully Made in Italy, which gives you unequalled performance in both an ice-cream parlor and at home.



THE SPECIAL MIX NYLON & FIBERGLASS

MATERIALE

L'INNOVATIVA COMPOSIZIONE DI NYLON E FIBERGLASS CONIUGA UN'ELEVATA RIGIDITÀ E UNA GRANDE RESISTENZA MECCANICA AD UNA STRAORDINARIA LEGGEREZZA. HA UN RANGE TERMICO DA -30°C A +170°C, È TRANQUILLAMENTE LAVABILE IN LAVASTOVIGLIE ED È PIENAMENTE A NORMA CON LE LEGGI CEE E FDA USA.

CREMAGLIERA

IL GIOCO DEL MECCANISMO, CALIBRATO ALLA PERFEZIONE, CONSENTE LA MASSIMA SCORREVOLEZZA CON IL MINIMO SFORZO DI PRESSIONE, RIDUCENDO QUINDI FATICA E STANCHEZZA.

FASCETTA

REALIZZATA IN ACCIAIO INOX OFFRE UN TAGLIO OTTIMALE DEL GELATO E, ASSIEME ALLA COPPA LUCIDATA, PRODUCE SEMPRE PALLINE PERFETTE.

ASTINA E MOLLA

ANCH'ESSE IN ACCIAIO INOX POSSIEDONO UN'EFFICACIA DI FUNZIONAMENTO SENZA PARI ASSOCIATA A MASSIMA ROBUSTEZZA, INALTERABILITÀ DI FUNZIONAMENTO E DURATA NEL TEMPO.

PERNO CENTRALE

IL CONTROLLO SCRUPOLOSO DELLE TOLLERANZE IN FASE DI STAMPAGGIO PRIMA ED IN ASSEMBLAGGIO POI, ASSIEME AL DESIGN COMPATTO, GARANTISCONO LA MASSIMA IGIENICITÀ DEL PORZIONATORE PER L'ASSENZA DI PUNTI OVE POSSA DEPOSITARSI LO SPORCO.

IMPUGNATURA

PERFETTAMENTE ERGONOMICA E, GRAZIE ALLA SPECIALE SUPERFICIE SATINATA, È TOTALMENTE ANTISCIVOLO PER UNA PRESA SEMPRE SALDA E SICURA.

MATERIAL

THE INNOVATIVE COMPOSITION OF NYLON AND FIBERGLASS MATCHES STIFFNESS, GREAT MECHANICAL STRENGTH AND EXTRAORDINARY LIGHTNESS. IT STANDS TEMPERATURES FROM -30°C TO +170°C, IS DISHWASHER SAFE AND FULLY COMPLIES WITH EEC AND FDA STANDARDS.

RACK

THE PERFECTLY ADJUSTED MECHANISM PROVIDES EXCELLENT SLIDING WITH MINIMUM PRESSURE EFFORT, THEN CUTTING DOWN FATIGUE AND TIREDNESS.

STRIP

MADE OF STAINLESS STEEL, IT PROVIDES THE BEST CUT OF ICE-CREAM AND, TOGETHER WITH THE POLISHED CUP, ALWAYS RESULTS IN PERFECT SHAPE SCOOPS.

ROD AND SPRING

THEY ARE ALSO MADE OF STAINLESS STEEL AND THEIR OPERATION IS UNPARALLELED; THEY ARE VERY STRONG, HAVE A LONG LIFE AND THEIR OPERATION UNDERGOES NO CHANGE.

CENTRAL HUB

CAREFUL CHECK ON ALLOWANCES, FIRST DURING THE MOLDING AND THEN THE ASSEMBLY STAGE, GUARANTEES, TOGETHER WITH COMPACT DESIGN, TOP HYGIENE OF THE SCOOP BECAUSE THERE ARE NO AREAS WHERE RESIDUES OF DIRT CAN SETTLE.

HANDLE

PERFECTLY ERGONOMIC AND, WITH ITS SPECIAL MATTE SURFACE, IT IS FULLY ANTI-SLIP FOR A STRONG AND SAFE GRIP AT ALL TIMES.





Spatola per gelato

Ice-cream server	Cod.	L cm	Box
	040020	20	5
	040025	25	5



Spatola per gelato manico tubolare chiuso

Ice-cream server	Cod.	L cm
	040125	25



Spatola per gelato manico tubolare aperto

Ice-cream server	Cod.	L cm	Box
	040225	25	5
	040230	30	5



Spatola per gelato manico colorato

Ice-cream server	Cod.	L cm	Col.
	040500	25	○
	040501	25	●
	040502	25	●
	040503	25	●



Spatola per gelato manico colorato trasparente 25 cm

Ice-cream server 25 cm	Cod.	L cm	Col.
	040507	25	○
	040511	25	●
	040512	25	●
	040513	25	●
	040517	25	●
	040518	25	●



Spatola per gelato manico colorato

Design by Donato Bainotti

Ice-cream server	Cod.	L cm	Col.	Box
	040300	25	○	5
	040301	25	●	5
	040302	25	●	5
	040303	25	●	5



Spatola per gelato manico colorato

Ice-cream server	Cod.	L cm	Col.	Box
	040600	30	○	5
	040601	30	●	5
	040602	30	●	5
	040603	30	●	5



Bacinella gelato 265 x 160

Ice-cream container	Cod.	L x W cm	H cm	cl
	045215	26,5 x 16	15	400
	045217	26,5 x 16	17	470



Coperchio in plastica

Plastic lid	Cod.	L x W cm
	045726	26,5 x 16
	045733	33 x 16,5
	045736	36 x 16,5



Bacinella gelato 330 x 165

Ice-cream container	Cod.	L x W cm	H cm
	045312	33 x 16,5	12
	045315	33 x 16,5	15
	045318	33 x 16,5	18



Lavaporzionatori

Ice-cream scoop - basin	Cod.	L x W cm	H cm
	045800	27 x 11	12



Bacinella gelato 360 x 165

Ice-cream container	Cod.	L x W cm	H cm	cl
	045408	36 x 16,5	8	350
	045412	36 x 16,5	12	500
	045415	36 x 16,5	15	650
	045418	36 x 16,5	18	770



Carapina stampata 200 x 250

Cylindrical ice-cream container	Cod.	Ø cm	H cm
	045900	20	25



Bacinella gelato 360 x 250

Ice-cream container	Cod.	L x W cm	H cm	cl
	045507	36 x 25	7	470
	045512	36 x 25	12	800



Bacinella gelato in polipropilene

Polypropylene ice-cream container	Cod.	L x W cm	H cm
	047008	36 x 25	8





Tappo versatore con capsula di chiusura

Pouring cork with closure cap

Cod. **0500004**



ADATTO A
SUITABLE FOR
Ø mm 19 > 21,5

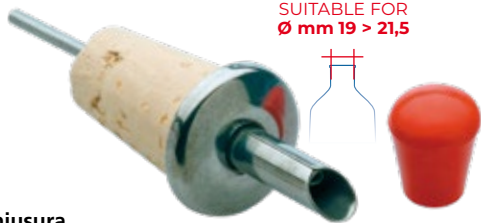

Tappo versatore curvo

Curved pouring cork

Cod. **0503004**



ADATTO A
SUITABLE FOR
Ø mm 19 > 21



Tappo versatore dritto

Straight pouring cork

Cod. **0501004**



ADATTO A
SUITABLE FOR
Ø mm 19 > 21



Tappo versatore curvo con silicone

Curved pouring cork with silicone

Cod. **0503014**



ADATTO A
SUITABLE FOR
Ø mm 17,5 > 18



Tappo versatore dritto con silicone

Straight pouring cork with silicone

Cod. **0501014**



ADATTO A
SUITABLE FOR
Ø mm 17,5 > 18



Tappo versatore recuperatore

Drop stop pouring cork

Cod. **0505004**



ADATTO A
SUITABLE FOR
Ø mm 19 > 21



Tappo versatore dritto con capsula di chiusura

Straight pouring cork with closure cap

Cod. **0502004**



ADATTO A
SUITABLE FOR
Ø mm 19 > 21

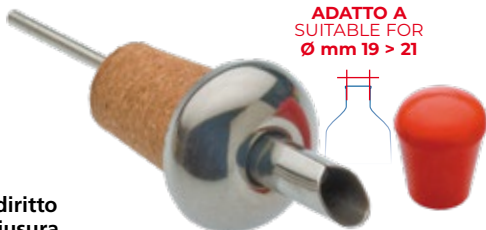

Tappo versatore recuperatore con silicone

Drop stop pouring cork with silicone

Cod. **0505014**



ADATTO A
SUITABLE FOR
Ø mm 17,5 > 18



Tappo versatore dritto con silicone e capsula di chiusura

Straight pouring cork with silicone and closure cap

Cod. **0502014**



ADATTO A
SUITABLE FOR
Ø mm 17,5 > 18



Confezione 4 tappi versatori (2 pz. 050000 + 2 pz. 050300)

Pack 4 pouring corks (2 pcs. 050000 + 2 pcs. 050300) Cod. **050601**







ADATTO A
SUITABLE FOR
Ø mm 17,5 > 18



Design by Marco Valente

**Tappo versatore con
silicone Design-Pourer**

Design-Pourer silicone gear Cod. **050800**

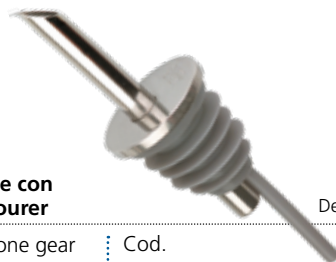

ADATTO A
SUITABLE FOR
Ø mm 17,5 > 18



Design by Marco Valente

**Tappo versatore con
silicone Tech-Pourer**

Tech-Pourer silicone gear Cod. **0509004**



ADATTO A
SUITABLE FOR
Ø mm 17,5 > 18



Design by Marco Valente

**Tappo versatore con
silicone Soft-Pourer**

Pourer Soft-Pourer Cod. **0512004**

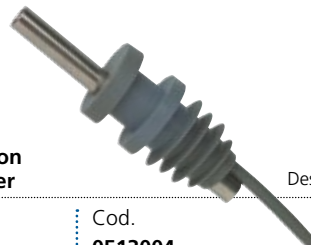

ADATTO A
SUITABLE FOR
Ø mm 17,5 > 18



Design by Marco Valente

**Tappo versatore con
silicone Soft-Pourer**

Pourer Soft-Pourer Cod. **0513004**



051400
051500



051601



**Capsula, sughero e silicone
per tappo versatore**

Capsule cork and silicone for pouring cork	Cod.	Per/For	Box
	051400	050000	24
	051500	050200	24
	051600		24
	051601		24



Silicone per tappi Pourers

Spare part for Pourers	Cod.	Box
	051700	24





ADATTO A
SUITABLE FOR
Ø mm 17,5 > 18



Design by Marco Valente

**Tappo versatore con
silicone Tech-Pourer**

Tech-Pourer silicone gear Cod. **0510004**

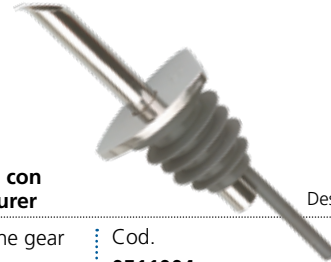

ADATTO A
SUITABLE FOR
Ø mm 17,5 > 18



Design by Marco Valente

**Tappo versatore con
silicone Tech-Pourer**

Tech-Pourer silicone gear Cod. **0511004**

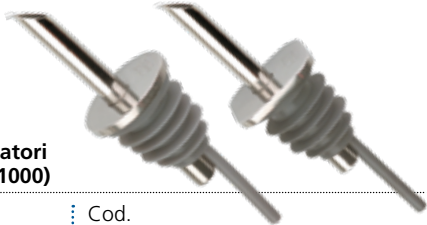

**Confezione 4 tappi versatori
(2 pz. 050900 + 2 pz. 051000)**

Pack 4 pouring corks Cod. **051301**
(2 pcs. 050900 + 2 pcs. 051000)



I TAPPI VERSATORI PIAZZA: SINTESI PERFETTA DI TRADIZIONE E INNOVAZIONE
PIAZZA POURERS: A PERFECT SYNTHESIS BETWEEN TRADITION AND INNOVATION

I tappi versatori sono parte della storia di PIAZZA. L'applicazione di materiali e tecnologie innovative all'oggetto che per primo ha dato avvio alla produzione di utensili professionali in acciaio PIAZZA, è simbolo di costante ed approfondita ricerca di qualità e funzionalità. Sintesi di acciaio e silicone il tappo versatore in Soflex esalta le caratteristiche positive di entrambi i materiali; all'ormai sperimentata praticità dei particolari in acciaio:

- BECCUCCIO SALVAGOCCIA
 - CANNUCCIA PER L'ARIA
 - ROBUSTO ED IGIENICO COPERCHIO
- si aggiunge un rivestimento lamellare in soflex, che, per le intrinseche caratteristiche del materiale e per l'appositamente studiata conformazione a lamelle, garantisce un impiego perfetto,
- INSERIMENTO FACILE E RESISTENZA ALLA FUORIUSCITA
 - CHIUSURA ERMETICA
 - SCORRIMENTO AGEVOLATO DI OGNI TIPO DI LIQUIDO (OLIO, LIQUORE, VINO)
 - NESSUN RISCHIO DI PERDITA, DI SCIVOLAMENTO DEL TAPPO, DI PERMANENZA DI ODORE SULLA PARTE IN SOFLEX

Pourers are part of PIAZZA's industrial history. The application of innovative materials and technologies to the object which first triggered production of PIAZZA professional utensils in steel, is symbol of the constant, in-depth search for quality and functionality. A synthesis of steel and silicone, the pourers in silicone highlight the positive features of both materials: to the well tried practicality of the details in steel,

- DRIP-CATCHER SPOUT
 - AIR INLET AND TOUGH
 - HYGIENIC LID
- is added a lamellar covering in silicone which, due to the intrinsic characteristics of the material and the specially designed lamella conformation, guarantees perfect use
- EASY INSERTION
 - RESISTANCE TO LEAKS,
 - HERMETIC CLOSURE WITH EASY FLOW OF ALL TYPES OF LIQUIDS (OIL, LIQUEUR, VINEGAR)
 - NO RISK OF LEAKING, OF THE CORK SLIPPING OR OF ODOURS REMAINING ON THE PART IN SILICONE

**Tappo versatore
per vino con chiusura**

Closable wine-pouring stopper Cod. **051800**

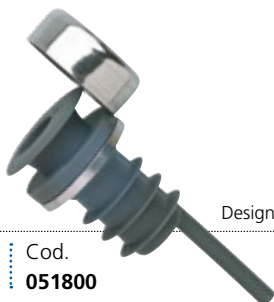

ADATTO A
SUITABLE FOR
Ø mm 17,5 > 18

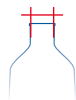

Design by Marco Valente

Box 18

Silicone per tappo vino (051800)

Spare part for pourer 051800 Cod. **051900**



Box 24



ADATTO A
SUITABLE FOR
Ø mm 17,5 > 18



**Tappo versatore dosatore
in acciaio inox**

Measuring stainless steel
pourer

Cod. 05321012



ADATTO A
SUITABLE FOR
Ø mm 17,5 > 18



**Tappo versatore dosatore
inox con chiusura**

Measuring stainless steel
pourer with lid

Cod. 05325012



BPour, tester per dosaggi

BPour, pour check

Cod.	Ø cm	H cm
053290	10,5	16,5



Tappo versatore metrico

Metric pourer

Cod.	ml	Col.
0540153	15	●
0540203	20	●
0540253	25	●
0540303	30	●
0540353	35	●
0540403	40	●
0540503	50	○





Cod. 0533002



Cod. 0533006

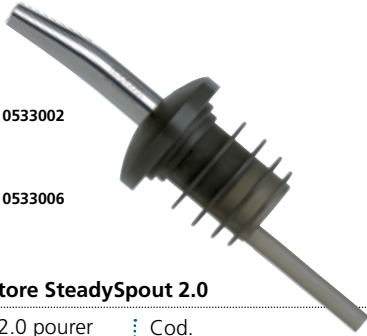

ADATTO A
SUITABLE FOR
Ø mm 18,5 > 21



Tappo versatore SteadySpout 2.0

SteadySpout 2.0 pourer Cod.
0533002
Cod. 0533006 0533006



Cod. 0533006

STEADYSPOUT^{2.0}

THE EVOLUTION OF THE METAL POURER

Con SteadySpout avrai un versaggio sempre costante a 157BPM, l'unità di misura usata dai bartender per calibrare perfettamente la quantità di liquido nella preparazione dei cocktail.

INALTERABILE

La speciale plastica dotata di "memoria" torna alla forma originale con un passaggio in lavastoviglie.

ROBUSTO

Composto da 2 soli pezzi invece che 4. Più solido e più resistente all'usura.

Maggiore durata nel tempo rispetto ai diretti concorrenti.

PRECISO

Velocità d'uscita del liquido garantita dalla presa d'aria. Nessuna goccia sia all'inizio che alla fine del versaggio. Ideale per la tecnica del jumping.

UNIVERSALE

Disegno e materiale delle lamelle offrono massima presa e inserimento/disinserimento facile e veloce. Il doppio modulo di diametro lo rende adatto a bottiglie con collo da Ø18 a Ø21,5 mm.

BREVETTATO

Concepito, studiato e interamente progettato dall'ufficio tecnico di PIAZZA. 100% Made in Italy.

CARATTERISTICHE TECNICHE

- Cannuccia in acciaio inox 18/10 AISI 304 con lavorazione al laser
- Diametro, rastrematura e inclinazione della cannuccia perfettamente calibrati sia all'interno che all'esterno
- Lavabile in lavastoviglie

TECHNICAL SPECIFICATIONS

- Reed in AISI 304 18/10 laser processed stainless steel
- Perfectly calibrated diameter, tapering and inclination of the reed, both inside and outside
- Dishwasher friendly



SCOPRI COME
LO PRODUCIAMO
DISCOVER HOW
WE MANUFACTURE IT



With SteadySpout, the rate of pouring is always constant at 157BPM, the unit of measurement used by bartenders to perfectly calibrate the quantity of liquid in the preparation of cocktails.

NEVER CHANGES

Special plastic with "memory" returns to the original shape simply by putting it through the dishwasher.

STURDY

Composed of only 2 pieces rather than 4. Sturdier and more resistant to wear and tear. Longer duration compared to the other competitors.

ACCURATE

Pouring speed of the liquid guaranteed by the air intake. No spills either at the start or end of the pouring. Perfect for the jumping technique.

UNIVERSAL

Design and material of the reed valves offer maximum grip and an easy and fast plugging/unplugging. The double diameter module makes it suitable for bottles with necks of diameters from Ø18 to Ø21.5 mm.

PATENTED

Conceived, developed and entirely designed by PIAZZA's technical office. Entirely manufactured in Italy



FEEL THE BEAT
MIX THE DRINKS

**Colino a rete**

Mesh strainer

Cod.	Ø cm
060007	7
060009	9
060012	12
060014	14
060016	16
060018	18

**Colino a rete conico**

Conical mesh strainer

Cod.	Ø cm
060107	7
060109	9
060112	12
060114	14
060116	16
060118	18



Un vasto assortimento di articoli finalizzati a “scolare” gli alimenti, denota un’attenzione particolare al problema. La serie dei colini si distingue per la rete impiegata, la cui trama è fitta e resistente, nonché per la sua saldatura al corpo, rifinita e durevole.

A vast assortment of articles for straining foodstuffs, featuring special attention paid to the problem. The series of strainers is distinguished by the tough, close-mesh employed as well as by the lasting and well-finished welding to the body.



CUCINA

COOKWARE

MOLLE CUCINA KITCHEN TONGS	32
COLLEZIONI PENTOLAME COOKWARE COLLECTIONS	34
ACCESSORI CUCINA KITCHEN ACCESSORIES	48
ARTICOLI TECNICI TECHNICAL ITEMS	70
COLTELLI KNIVES	72
CESTELLI RACKS	80
GASTRONORM ACCIAIO INOX STAINLESS STEEL GASTRONORM	82
GASTRONORM POLICARBONATO POLYCARBONATE GASTRONORM	86
GASTRONORM POLIPROPILENE POLYPROPYLENE GASTRONORM	88
CONTENITORI STORPLUS STORPLUS CONTAINERS	89



Molla Test

Design by Michele Capuani

Test tongs	Cod.	L cm	Box
	014100	13,5	12



Molla Kaiman

Design by Michele Capuani

Kaiman tongs	Cod.	L cm	Box
	014200	18	12



Molla di precisione per cucina

Design by Michele Capuani

Precision kitchen tongs	Cod.	L cm	Box
	014500	30	12
	014515	15	12
	014523	23,5	12



Molla di precisione 40° per cucina

Design by Michele Capuani

40° precision kitchen tongs	Cod.	L cm	Box
	014600	30	12
	014615	15	12
	014623	23,5	12



Molla universale per cucina

Design by Michele Capuani

All-in-one kitchen tongs	Cod.	L cm	Box
	015000	30	12
	015012	12	12
	015018	18	12
	015023	23,5	12



Molla fonda per cucina

Design by Michele Capuani

Curved kitchen tongs	Cod.	L cm	Box
	015500	30	12
	015518	18	12
	015523	23,5	12



SBLOCCO FACILE
EASY RELEASE



MOLLA A SCOMPARSA
DROP SPRING



Molla universale nylon & fiberglass

Design by Michele Capuani

Nylon & fiberglass all-in-one tongs	Cod.	L cm	Box
	01822302	23	12
	01823002	30	12
	01824002	40	12



Molla di precisione nylon & fiberglass

Design by Michele Capuani

Nylon & fiberglass precision tongs	Cod.	L cm	Box
	01833000	30	12



Molla universale nylon

Design by Michele Capuani

Nylon all-in-one tongs	Cod.	L cm	Box
	018600	23	12
	018700	30	12



SCOPRI LA QUALITÀ
100% MADE IN ITALY
DISCOVER THE QUALITY
100% MADE IN ITALY

IL PENTOLAME PIAZZA: EFFICIENTE E SICURO IN QUALUNQUE CONDIZIONE

PIAZZA COOKWARE: EFFICIENT AND SAFE IN ANY SITUATION

Per la cucina professionale "massima funzionalità" è una parola d'ordine.

Tutte le collezioni di pentolame PIAZZA sono frutto di una ricerca avanzata e costante e interpretano in modo esemplare questa importante esigenza.

Il redesign della collezione 5 stelle ne è l'esempio migliore, unendo perfettamente tradizione e innovazione.

Un particolare classico, come la maniglia brevettata, conserva intatte tutte le caratteristiche che garantiscono una resistenza infinita e le migliori performance del mercato, guadagnando però un differente processo di lucidatura che la rende ancora più bella.

Il nuovo manico casseroles e padelle è invece espressione della capacità innovativa del design italiano.

Composto da un unico pezzo dalla forma aperta, offre una perfetta ergonomia e una resistenza ottimale,

assicurando al tempo stesso la

massima igienicità. Infine, grazie ad un nuovo processo di produzione ad alta tecnologia, il fondo ha ora dimensioni e spessori maggiorati, che si traducono in una migliore efficienza e una conduzione termica ottimale su qualunque superficie di cottura utilizzata (gas, induzione, elettrica, vetroceramica).

- ALTI SPESSORI
- ROBUSTEZZA
- RESISTENZA ALL'USURA
- FINITURE DI PREGIO
- SALDATURE INDISTRUTTIBILI
- MANIGLIE CAVE ED ERGONOMICHE

- THICK
- TOUGH
- WEAR-RESISTANT
- FINE FINISH
- INDESTRUCTIBLE WELDING
- HOLLOW ERGONOMIC HANDLES

"Top functionality" is the keyword for professional cooking. All PIAZZA lines of pots and pans are the result of continuous state-of-the-art research and a perfect example of interpretation of this important requirement.

The new design of the 5 Stars collection, which perfectly mixes tradition and innovation, is the best example of this concept. The patented handle, a classical detail, maintains all characteristics that have guaranteed and still guarantees endless strength and top performance on the market, and has been embellished with a different polishing process.

The new handle of casseroles and pans, instead, is the expression of the innovative skills of Italian designers. Consisting of a single, open-shaped piece, it features excellent ergonomics and great strength, and simultaneously assures top hygiene characteristics.

Finally, with a new high-technology manufacturing process, the size and thickness of the bottom are more generous, and this translates into greater efficiency and excellent heat conduction on any cooking surface (gas, induction, electric, glass-ceramic).



MANIGLIE PIAZZA

ALTRE MANIGLIE

PIAZZA'S HANDLES

OTHER HANDLES

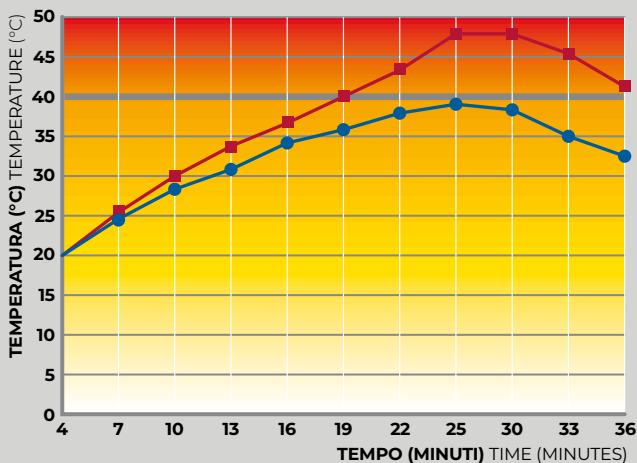

IL GRAFICO MOSTRA I VALORI DELLE TEMPERATURE RAGGIUNTI DALLE MANIGLIE DELLE PENTOLE DELLA SERIE "5 STELLE" PIAZZA CONFRONTATI CON QUELLI DELLE ALTRE MANIGLIE PRESENTI SUL MERCATO. COME SI PUÒ NOTARE, SE VENGONO USATE IN MANIERA CORRETTA, LE MANIGLIE PIAZZA NON RAGGIUNGONO MAI IL PUNTO CRITICO DEI 40°C (SOPRA IL QUALE LE MANI SI SCOTTANO) ANCHE QUANDO L'ACQUA È A 98°C.

THE GRAPHIC SHOWS THE VALUES OF THE TEMPERATURE REACHED BY PIAZZA'S HANDLES COMPARED TO THE ONE OF THE OTHER HANDLES ON THE MARKET. AS YOU SEE THE TEMPERATURE OF PIAZZA'S HANDLES NEVER REACHES THE CRITIC POINT OF 40°C EVEN WITH WATER AT 98°C, IF USED IN THE PROPER WAY. ABOVE THIS CRITIC POINT HANDS GET BURNT.





Casseruola bassa

Shallow cookpot	Cod.	Ø cm	H cm	Lt
	090024	24	8	3,6
	090028	28	9	5,6
	090032	32	10	8,1
	090036	36	11	11,3
	090040	40	13	16,4
	090045	45	14	22,4
	090050	50	16	31,6



Casseruola bassa 1 manico

Shallow saucepan	Cod.	Ø cm	H cm	Lt
	090124	24	8	3,6
	090128	28	9	5,6
	090132	32	10	8,1



Casseruola media

Medium cookpot	Cod.	Ø cm	H cm	Lt
	090216	16	8	1,6
	090220	20	9	2,8
	090224	24	10	4,5
	090228	28	12	7,4
	090232	32	15	12,1
	090236	36	17	17,4
	090240	40	19	24
	090245	45	22	35,1
	090250	50	25	49,3



Casseruola media 1 manico

Medium saucepan	Cod.	Ø cm	H cm	Lt
	090316	16	8	1,6
	090320	20	9	2,8
	090324	24	10	4,5
	090328	28	12	7,4



Casseruola alta

Deep cookpot	Cod.	Ø cm	H cm	Lt
	090416	16	11	2,2
	090420	20	13	4,1
	090424	24	15	6,8
	090428	28	18	11,1
	090432	32	20	16,1
	090436	36	22	22,5
	090440	40	25	31,5
	090445	45	28	44,7
	090450	50	32	63



Casseruola alta 1 manico

Deep saucepan	Cod.	Ø cm	H cm	Lt
	090516	16	11	2,2
	090520	20	13	4,1
	090524	24	15	6,8
	090528	28	18	11,1





Pentola

Pan	Cod.	Ø cm	H cm	Lt
	090620	20	20	6,3
	090624	24	24	10,9
	090628	28	28	17,3
	090632	32	32	25,8
	090636	36	36	36,7
	090640	40	40	50,3
	090645	45	45	71,7
	090650	50	50	98,3



Casseruola bombata

Curved saute pan	Cod.	Ø cm	H cm	Lt
	091216	16	6	1
	091218	18	6	1,2
	091220	20	6,5	1,5
	091222	22	7	1,95
	091224	24	7,5	2,5



Padella in acciaio con rivestimento antiaderente

Steel frying pan with non-stick coating	Cod.	Ø cm	H cm
	091720	20	4,5
	091724	24	5
	091728	28	5,5
	091732	32	6
	091736	36*	6,5
	091740	40*	7



* CON CONTROMANICO WITH A SECOND HANDLE



Padella

Frying pan	Cod.	Ø cm	H cm
	090720	20	4,5
	090724	24	5
	090728	28	5,5
	090732	32	6
	090736	36	6,5



Wok con rivestimento antiaderente

Wok with non-stick coating	Cod.	Ø cm	H cm
	091928	28	9



Coperchio

Lid	Cod.	Ø cm
	092916	16
	092920	20
	092924	24
	092928	28
	092932	32
	092936	36
	092940	40
	092945	45
	092950	50



Tegame

2-handled frying pan	Cod.	Ø cm	H cm
	095820	20	4,5
	095824	24	5
	095828	28	5,5
	095832	32	6
	095836	36	6,5
	095840	40	7
	095845	45	7,5
	095850	50	8





Casseruola bassa

Shallow cookpot	Cod.	Ø cm	H cm	Lt
	095024	24	8	3,6
	095028	28	9	5,6
	095032	32	10	8,1
	095036	36	11	11,3
	095040	40	13	16,4
	095045	45	14	22,4
	095050	50	16	31,6



Casseruola bassa 1 manico

Shallow saucepan	Cod.	Ø cm	H cm	Lt
	095124	24	8	3,6
	095128	28	9	5,6



Casseruola media

Medium cookpot	Cod.	Ø cm	H cm	Lt
	095216	16	8	1,6
	095220	20	9	2,8
	095224	24	10	4,5
	095228	28	12	7,4
	095232	32	15	12,1
	095236	36	17	17,4
	095240	40	19	24
	095245	45	22	35,1
	095250	50	25	49,3



Casseruola media 1 manico

Medium saucepan	Cod.	Ø cm	H cm	Lt
	095316	16	8	1,6
	095320	20	9	2,8
	095324	24	10	4,5
	095328	28	12	7,4



Casseruola alta

Deep cookpot	Cod.	Ø cm	H cm	Lt
	095416	16	11	2,2
	095420	20	13	4,1
	095424	24	15	6,8
	095428	28	18	11,1
	095432	32	20	16,1
	095436	36	22	22,5
	095440	40	25	31,5
	095445	45	28	44,7
	095450	50	32	63



Casseruola alta 1 manico

Deep saucepan	Cod.	Ø cm	H cm	Lt
	095516	16	11	2,2
	095520	20	13	4,1
	095524	24	15	6,8
	095528	28	18	11,1





Pentola

Pan	Cod.	Ø cm	H cm	Lt
	095620	20	20	6,3
	095624	24	24	10,9
	095628	28	28	17,3
	095632	32	32	25,8
	095636	36	36	36,7
	095640	40	40	50,3
	095645	45	45	71,7
	095650	50	50	98,3



Casseruola bombata

Curved saute pan	Cod.	Ø cm	H cm	Lt
	091216	16	6	1
	091218	18	6	1,2
	091220	20	6,5	1,5
	091222	22	7	1,95
	091224	24	7,5	2,5



Padella in acciaio con rivestimento antiaderente

Steel frying pan with non-stick coating	Cod.	Ø cm	H cm
	091720	20	4,5
	091724	24	5
	091728	28	5,5
	091732	32	6
	091736	36*	6,5
	091740	40*	7



* CON CONTROMANICO WITH A SECOND HANDLE



Padella

Frying pan	Cod.	Ø cm	H cm
	095720	20	4,5
	095724	24	5
	095728	28	5,5
	095732	32	6
	095736	36*	6,5
	095740	40*	7
	095745	45*	7,5
	095750	50*	8



* CON CONTROMANICO WITH A SECOND HANDLE



Wok con rivestimento antiaderente

Wok with non-stick coating	Cod.	Ø cm	H cm
	091928	28	9



Tegame

2-handled frying pan	Cod.	Ø cm	H cm
	095820	20	4,5
	095824	24	5
	095828	28	5,5
	095832	32	6
	095836	36	6,5
	095840	40	7
	095845	45	7,5
	095850	50	8



Coperchio

Lid	Cod.	Ø cm
	092916	16
	092920	20
	092924	24
	092928	28
	092932	32
	092936	36
	092940	40
	092945	45
	092950	50





Casseruola bassa

Shallow cookpot	Cod.	Ø cm	H cm	Lt
	093028	28	9	5,5
	093032	32	10	8
	093036	36	11	11,2
	093040	40	13	16,3
	093045	45	14	22,3
	093050	50	16	31,4



Casseruola media

Medium cookpot	Cod.	Ø cm	H cm	Lt
	093220	20	10,5	3,3
	093224	24	11	5
	093228	28	13	8
	093232	32	16	12,9



Casseruola alta

Deep cookpot	Cod.	Ø cm	H cm	Lt
	093416	16	12	2,4
	093420	20	14	4,4
	093424	24	16	7,2
	093428	28	18	11,1
	093432	32	20	16,1
	093436	36	22	22,4
	093440	40	25	31,4
	093445	45	28	44,5
	093450	50	32	62,8



Coperchio

Lid	Cod.	Ø cm
	093916	16
	093920	20
	093924	24
	093928	28
	093932	32
	093936	36
	093940	40
	093945	45
	093950	50



Padella

Frying pan	Cod.	Ø cm	H cm	Lt
	093720	20	4	1,2
	093724	24	4	1,7
	093728	28	5	2,9
	093732	32	5	3,8
	093736	36	6,5	6,3
	093740	40	7	8,4



Casseruola media 1 manico

Medium saucepan	Cod.	Ø cm	H cm	Lt
	093316	16	9,5	1,9
	093320	20	10,5	3,3
	093324	24	11	5
	093328	28	12	7,5



Casseruola alta 1 manico

Deep saucepan	Cod.	Ø cm	H cm	Lt
	093516	16	12	2,4
	093520	20	14	4,4
	093524	24	16	7,2
	093528	28	18	11,1



Pentola

Pan	Cod.	Ø cm	H cm	Lt
	093624	24	24	10,9
	093628	28	28	16
	093632	32	32	25,8
	093636	36	36	36,6
	093640	40	40	50,2
	093645	45	45	71,5





Padella in acciaio con rivestimento antiaderente

Steel frying pan with non-stick coating	Cod.	Ø cm	H cm
	091720	20	4,5
	091724	24	5
	091728	28	5,5
	091732	32	6
	091736	36*	6,5
	091740	40*	7



* CON CONTROMANICO WITH A SECOND HANDLE



Wok con rivestimento antiaderente

Wok with non-stick coating	Cod.	Ø cm	H cm
	091928	28	9



LE PADELLE ANTIADERENTI: PRATICHE, ROBUSTE, INALTERABILI
NON-STICK FRYING PANS: PRACTICAL, ROBUST, INALTERABLE

Le padelle antiaderenti PIAZZA vantano il trattamento di alta qualità Teflon® Select, che garantisce loro una durata nel tempo oltre sette volte maggiore rispetto ai rivestimenti in ceramica o silicone.

La speciale tecnologia multistrato assicura prestazioni superiori in fase di cottura, impedisce ai cibi di attaccarsi al fondo e resiste in modo ottimale a graffi ed abrasioni, consentendo così l'utilizzo di accessori da cucina in metallo. Sono facili da pulire e possono essere tranquillamente lavate in lavastoviglie.

Our PIAZZA non-stick frying pans are all subject to the high quality Teflon® Select treatment, which guarantees they will last more than seven times longer than ceramic or silicon coatings. The special multi-layer technology guarantees superior performance during cooking, preventing food from sticking to the base and providing optimal resistance against scratches and abrasion, whilst also allowing metal kitchen utensils to be used. Our frying pans are easy to clean and are all fully dishwasher-safe.

TEMPERATURA OTTIMALE DI COTTURA OPTIMAL COOKING TEMPERATURE	240° C (464° F)
TEMPERATURA MASSIMA DI UTILIZZO MAXIMUM USE TEMPERATURE	340° C (644° F)

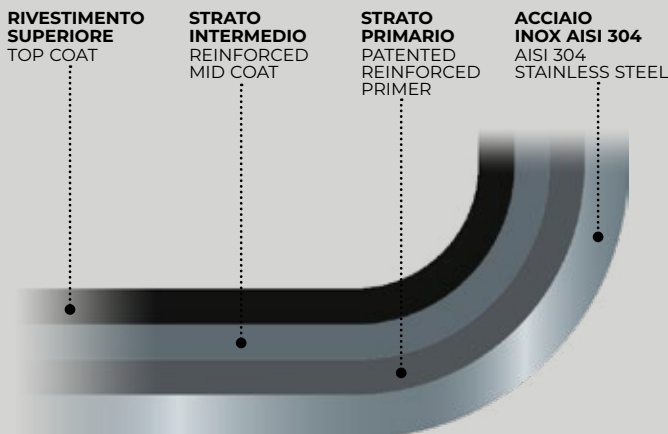

Teflon® è un marchio commerciale registrato di E.I. Du Pont de Nemours and Company
Teflon® is a registered trademark of E.I. Du Pont de Nemours and Company





Rostiera rettangolare alta

High rectangular roaster	Cod.	L x W cm	Lt
	101525	25 x 18	3
	101530	30 x 22	4
	101535	35 x 25	6
	101540	40 x 28	9
	101545	45 x 30	13
	101550	50 x 35	17,5
	101560	60 x 40	27



Vassoio rettangolare

Rectangular Tray	Cod.	L x W cm
	101630	30 x 23
	101635	35 x 28
	101640	40 x 30
	101645	45 x 35
	101650	50 x 35
	101655	55 x 35
	101660	60 x 40



Casseruola bassa

Shallow cookpot	Cod.	Ø cm	H cm	Lt
	102024	24	8	3,6
	102028	28	9,3	5,6
	102032	32	10,6	8,1
	102036	36	12	11,3
	102040	40	13,3	16,4
	102045	45	15	22,4
	102050	50	16,6	31,6



Casseruola media

Medium cookpot	Cod.	Ø cm	H cm	Lt
	102220	20	10	3
	102224	24	12	5,5
	102228	28	14	8,5
	102232	32	16	13
	102236	36	18	18
	102240	40	20	25
	102245	45	22,5	36
	102250	50	25	49



Casseruola media 1 manico

Medium saucepan	Cod.	Ø cm	H cm	Lt
	102316	16	8	1,5
	102320	20	10	3
	102324	24	12	5,5
	102328	28	14	8,5



Casseruola alta

Deep cookpot	Cod.	Ø cm	H cm	Lt
	102420	20	13,3	4
	102424	24	16	7
	102428	28	18,6	11,5
	102432	32	21,3	17
	102436	36	24	24,5
	102440	40	26,6	34





Casseruola alta 1 manico

Deep saucepan	Cod.	Ø cm	H cm	Lt
	102516	16	10,6	2
	102520	20	13,3	4
	102524	24	16	7



Pentola

Pan	Cod.	Ø cm	H cm	Lt
	102620	20	20	6
	102624	24	24	11
	102628	28	28	17
	102632	32	32	26
	102636	36	36	37
	102640	40	40	50
	102645	45	45	71,5
	102650	50	50	98



Padella svasata bassa

Shallow flared frying pan	Cod.	Ø cm	H cm
	102720	20	4,5
	102724	24	5
	102728	28	5,5
	102732	32	6
	102736	36	6,5
	102740	40	7



Padella svasata alta

Deep frying pan	Cod.	Ø cm	H cm
	1027200	20	5
	1027240	24	6
	1027280	28	6,5
	1027320	32	7
	1027360	36	7,5
	1027400	40	8,5



Tegame

2-handled frying pan	Cod.	Ø cm	H cm
	102820	20	4,5
	102824	24	6
	102828	28	6,5
	102832	32	7
	102836	36	7,5
	102840	40	8
	102845	45	8
	102850	50	8



Coperchio

Lid	Cod.	Ø cm
	102916	16
	102920	20
	102924	24
	102928	28
	102932	32
	102936	36
	102940	40
	102945	45
	102950	50



Casseruola bassa antiaderente

Shallow cookpot with non-stick coating

Cod.	Ø cm	H cm	Lt
105024	24	8	3,5
105028	28	9,5	6
105032	32	10,5	8,5

Casseruola media antiaderente

Medium cookpot with non-stick coating

Cod.	Ø cm	H cm	Lt
105220	20	10	3
105224	24	12	5,5
105228	28	14	8,5

Casseruola media 1 manico antiaderente

Medium saucepan with non-stick coating

Cod.	Ø cm	H cm	Lt
105316	16	8	1,5
105320	20	10	3
105324	24	12	5,5

Padella svasata bassa antiaderente

Shallow flared frying pan with non-stick coating

Cod.	Ø cm	H cm
105724	24	5
105728	28	5,5
105732	32	6
105736	36	6,5
105740	40	7

Padella svasata alta antiaderente

Deep frying pan with non-stick coating

Cod.	Ø cm	H cm
1057200	20	5
1057240	24	6
1057280	28	6,5
1057320	32	7
1057360	36	7,5
1057400	40	8,5

Tegame svasato antiaderente

Flared pan with non-stick coating

Cod.	Ø cm	H cm
105824	24	6
105828	28	6,5
105832	32	7
105836	36	7,5
105840	40	8



IL PENTOLAME MULTISTRATO: UN INSIEME DI METALLI CHE LAVORANO IN SINTONIA COME UN'ORCHESTRA

THE MULTI-LAYER COOKWARE: A SET OF DIFFERENT METALS WORKING IN HARMONY LIKE AN ORCHESTRA

Le collezioni di pentolame multistrato 3-PLY e 4-PLY sfruttano le diverse peculiarità dei singoli materiali che le compongono.

Nascono così assortimenti completi, studiati per offrirvi prestazioni di assoluta eccellenza, senza rinunciare a praticità e maneggevolezza in ogni situazione di preparazione e servizio, in cucina come in sala.

- **SPESSORE 1,2 MM (3-PLY) E 2 MM (4-PLY)**
- **BORDO A VERSARE**
- **UTILIZZABILI SU OGNI TIPO DI PIASTRA DI COTTURA (GAS, INDUZIONE, ELETTRICA, VETROCERAMICA) GARANTENDO SEMPRE CONDUCIBILITÀ OTTIMALE**
- **LA PERFETTA ERGONOMIA DEL MANICO IN ACCIAIO INOX CONSENTE UNA PRESA SEMPRE SICURA E CONFORTEVOLE**
- **IL PROFILO DELLA SALDATURA DI MANICO E MANIGLIE OFFRE GARANZIA DI MASSIMA TENUTA MENTRE L'APERTURA SUPERIORE NE PERMETTE IL RAFFREDDAMENTO GRAZIE AL PASSAGGIO DELL'ARIA. IL DISEGNO APERTO FORNISCE INOLTRE LA MASSIMA IGIENICITÀ IN FASE DI LAVAGGIO**
- **NELLA COLLEZIONE 4-PLY IL FONDO NON È APPLICATO, MA MESSO A NUDO RIMUOVENDO LO STRATO ESTERNO IN RAME, PER OFFRIRE ROBUSTEZZA E DURATA NEL TEMPO**
- **NEI DIAMETRI DA 8 A 16 CM IL COPERCHIO PUÒ ESSERE COMODAMENTE AGGANCIATO AL BORDO DELLE CASSERUOLE GRAZIE AL PARTICOLARE DISEGNO DEL TRAVERSINO**

The multi-layer cookware collections 3-PLY and 4-PLY takes advantage of the different peculiarities of the materials they are made of.

The results are complete ranges, designed to bring you excellent performance.

Always practical and easy to use in kitchen and in service room.

- **THICK 1.2 MM (3-PLY) AND 2 MM (4-PLY)**
- **POURING EDGE**
- **SUITABLE FOR GAS, INDUCTION, HOTPLATES AND CERAMIC, ALWAYS MAINTAINING HIGH CONDUCTIVITY**
- **ERGONOMIC HANDLES IN STAINLESS STEEL DESIGNED TO GIVE A SAFE AND COMFORTABLE GRIP**
- **THE SHAPE OF WELDING OF THE HANDLES ENSURES THE BEST SEALING WHILE THE UPPER OPENING ALLOWS COOLING. THE OPEN OUTLINE GUARANTEES THE EXCELLENT HYGIENE**
- **THE STEEL BOTTOM IS NOT APPLIED, YET EXPOSED BY REMOVING THE EXTERNAL COPPER LAYER: THIS RESULTS IN GREATER STRENGTH AND LONG-LIFE**
- **THE LIDS WITH DIAMETERS FROM 8 TO 16 CM CAN BE EASILY HOOKED TO THE RIM OF THE CASSEROLE THANKS TO THE SPECIAL DESIGN OF THE KNOB**



3-PLY COLLECTION

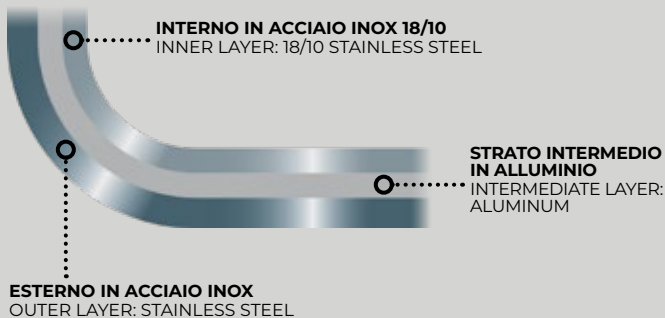

4-PLY COLLECTION

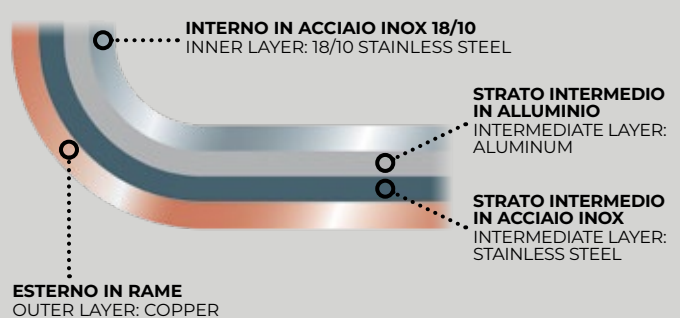



Casseruola bassa

Shallow cookpot	Cod.	Ø cm	H cm	Lt
	110020	20	7,5	2,3
	110024	24	8	3,6
	110028	28	9	5,6
	110032	32	10	8
	110036	36	11	11
	110040	40	13	16



Casseruola bassa 1 manico

Shallow saucepan	Cod.	Ø cm	H cm	Lt
	110120	20	7,5	2,3
	110124	24	8	3,6
	110128	28	9	5,6
	110132	32	10	8



Casseruola media

Medium cookpot	Cod.	Ø cm	H cm	Lt
	110210 ←	10	4,5	0,35
	110212 ←	12	6	0,7
	110214 ←	14	7	1
	110216 ←	16	8	1,6
	110220	20	9	2,8
	110224	24	10	4,5
	110228	28	12	7,4



Casseruola media 1 manico

Medium saucepan	Cod.	Ø cm	H cm	Lt
	110310 ←	10	4,5	0,35
	110312 ←	12	6	0,7
	110314 ←	14	7	1
	110316 ←	16	8	1,6
	110320	20	9	2,8
	110324	24	10	4,5
	110328	28	12	7,4



Casseruola alta

Deep cookpot	Cod.	Ø cm	H cm	Lt
	110408 ←	8	5	0,25
	110410 ←	10	6,5	0,5
	110412 ←	12	8	0,9
	110414 ←	14	9	1,4
	110416 ←	16	11	2,2
	110420	20	13	4,1
	110424	24	15	6,8
	110428	28	18	11
	110432	32	20	16
	110436	36	22	22,5
	110440	40	25	31,5



Casseruola alta 1 manico

Deep saucepan	Cod.	Ø cm	H cm	Lt
	110508 ←	8	5	0,25
	110510 ←	10	6,5	0,5
	110512 ←	12	8	0,9
	110514 ←	14	9	1,4
	110516 ←	16	11	2,2
	110520	20	13	4,1
	110524	24	15	6,8
	110528	28	18	11





Padella

Frying pan	Cod.	Ø cm	H cm
	110710 ←	10	3
	110712 ←	12	3
	110714 ←	14	3
	110716 ←	16	3
	110720	20	4,5
	110724	24	5
	110728	28	5,5
	110732	32	6
	110736	36	6
	110740	40*	6,5



* CON CONTROMANICO
WITH A SECOND HANDLE



Tegame

Two-handed frying pan	Cod.	Ø cm	H cm
	110810	10	3
	110812	12	3
	110814	14	3
	110816	16	3



Casseruola bombata

Curved saute pan	Cod.	Ø cm	H cm	Lt
	111218	18	6,5	1,2
	111220	20	7	1,5
	111222	22	7,5	1,9
	111224	24	8	2,5



Padella antiaderente

Frying pan non-stick	Cod.	Ø cm	H cm
	111720	20	4,5
	111724	24	5
	111728	28	5,5
	111732	32	6
	111736	36	6
	111740	40*	6,5



* CON CONTROMANICO
WITH A SECOND HANDLE



Padella quadrata giapponese

Japanese egg pan	Cod.	L x W cm	H cm
	111420	20 x 15	3,5
	111424	24,5 x 25	3,5



Coperchio

Lid	Cod.	Ø cm
	112908 ←	8
	112910 ←	10
	112912 ←	12
	112914 ←	14
	112916 ←	16
	092920	20
	092924	24
	092928	28
	092932	32
	092936	36
	092940	40





Casseruola media

Medium cookpot	Cod.	Ø cm	H cm	Lt
	113210	10	4,5	0,25
	113212	12	6	0,5
	113214	14	7	0,9
	113216	16	8	1,4



Casseruola media 1 manico

Medium saucepan	Cod.	Ø cm	H cm	Lt
	113310	10	4,5	0,25
	113312	12	6	0,5
	113314	14	7	0,9
	113316	16	8	1,4



Casseruola alta

Deep cookpot	Cod.	Ø cm	H cm	Lt
	113408	8	5	0,2
	113410	10	6,5	0,4
	113412	12	8	0,75
	113414	14	9	1,2
	113416	16	11	2



Casseruola alta 1 manico

Deep saucepan	Cod.	Ø cm	H cm	Lt
	113508	8	5	0,2
	113510	10	6,5	0,4
	113512	12	8	0,75
	113514	14	9	1,2
	113516	16	11	2



Padella

Frying pan	Cod.	Ø cm	H cm
	113710	10	3,5
	113712	12	3,5
	113714	14	3,5
	113716	16	3,5



Tegame

Two-handed frying pan	Cod.	Ø cm	H cm
	113810	10	3
	113812	12	3
	113814	14	3
	113816	16	3



Coperchio

Lid	Cod.	Ø cm
	112908	8
	112910	10
	112912	12
	112914	14
	112916	16







Spicchio per casseruola alta

Strainer for deep casserole	Cod.	Por.	Ø cm
	120128	1/3	28
	120132	1/3	32
	120136	1/4	36
	120140	1/4	40



Spicchio a rete per casseruola alta

Mesh strainer for deep casserole	Cod.	Por.	Ø cm
	120228	1/3	28
	120232	1/3	32
	120236	1/4	36
	120240	1/4	40



Scaldapasta

Warmer	Cod.	Ø cm
	120318	18
	120320	20
	120324	24
	120328	28



Chinois con gancio di appoggio posteriore

Chinois with rear support hook	Cod.	Ø cm
	120418	18
	120420	20
	120424	24



Chinois con gancio di appoggio anteriore

Chinois	Cod.	Ø cm
	120516	16
	120518	18
	120520	20
	120524	24



Chinois

Chinois	Cod.	Ø cm
	125114	14
	125116	16
	125118	18
	125120	20
	125122	22
	125124	24
	125126	26



Chinois a rete

Chinois	Cod.	Ø cm
	120620	20
	120624	24



Chinois a rete con protezione in filo

Chinois wire protection	Cod.	Ø cm
	120720	20
	120724	24





Tazzone

Kitchen bowl	Cod.	Ø cm	cl
	120816	16	125
	120818	18	150
	120822	22	300



Sessola

All-purpose scoop	Cod.	Ø cm	L cm
	121110	10	18
	121112	12	20
	121114	14	22
	121116	16	24



Tazzone con manico tubolare

Kitchen bowl	Cod.	Ø cm	cl
	120916	16	125
	120918	18	150
	120920	20	200
	120922	22	300
	120924	24	500



Bagnomaria

Bain marie pot	Cod.	Ø cm	H cm	cl
	121212	12	14	150
	121214	14	16	250
	121216	16	18	350
	121218	18	20	500
	121220	20	22	700



Tazzone tondo con manico tubolare

Round kitchen bowl	Cod.	Ø cm	cl
	121016	16	125
	121018	18	150
	121020	20	200



Timballo per dolci

Pie mould	Cod.	Ø cm	H cm	cl
	121506	5	5	6
	121511	6	6	11
	121515	6,5	6,5	15
	121517	7	7	17
	121528	8	8	28



Misurino graduato

Measuring jug	Cod.	cl
	121605	50
	121610	100
	121620	200

DIMENSIONI REALI
REAL DIMENSIONS

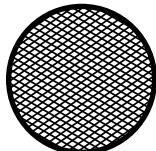

FORI HOLES
1 x 0,7 mm



Setaccio inox a velo

Stainless steel fine sieve

Cod.	Ø cm
121721	21
121730	30
121735	35



DIMENSIONI REALI
REAL DIMENSIONS

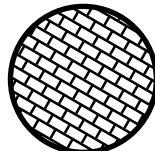

FORI HOLES
2,25 x 1,15 mm



Setaccio spargi farina automatico

Automatic flour sieve

Cod.	Ø cm	H cm
122500	16	16



DIMENSIONI REALI
REAL DIMENSIONS

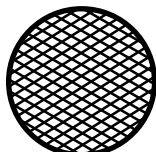

FORI HOLES
2 x 1,15 mm



Setaccio inox farina

Stainless steel flour sieve

Cod.	Ø cm
121821	21
121830	30
121835	35



Chinois

Chinois

Cod.	Ø cm
125114	14
125116	16
125118	18
125120	20
125122	22
125124	24
125126	26



DIMENSIONI REALI
REAL DIMENSIONS

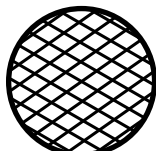

FORI HOLES
3,35 x 2,15 mm



Setaccio inox pane

Stainless steel bread crumbs sieve

Cod.	Ø cm
121930	30
121935	35



Bacinella

Bowl

Cod.	Ø cm	H cm	cl
130116	16,5	6,5	75
130120	20,5	8	150
130125	25	10,5	300
130127	27	11	400
130129	29,5	12,5	500
130133	33,5	13,5	800
130139	39,5	16	1400



DIMENSIONI REALI
REAL DIMENSIONS

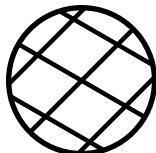

FORI HOLES
9,8 x 7,5 mm



Setaccio inox pesce

Stainless steel fish sieve

Cod.	Ø cm
122030	30
122035	35





Bastardella

Bowl	Cod.	Ø cm	H cm	cl
	130220	20	14	350
	130225	25	15	500
	130230	30	16	800
	130235	35	17,5	1200
	130240	40	20,5	1800



Secchio inox graduato

Graduated bucket - stainless steel	Cod.	cl
	135210	1000
	135212	1200



Base per bastardella

Ring for mixing bowl	Cod.
	130300



Secchio inox graduato con base

Graduated bucket with bottom ring - stainless steel	Cod.	cl
	135310	1000
	135312	1200
	135315	1500



Colapasta sferico con base

Round colander with base	Cod.	Ø cm	H cm	cl
	130425	25	15	500
	130430	30	16	800
	130435	35	17,5	1200
	130440	40	20,5	1800



Coperchio per secchio

Lid for bucket - stainless steel	Cod.	Per/For cl
	135408	800
	135410	1000
	135412	1200
	135415	1500



Bacinella per pasticceria e cucina bordata

Bowl	Cod.	Ø cm	H cm	cl
	130616	16	9	100
	130618	18	9	150
	130621	21	10	200
	130625	25	12,5	375
	130628	28,5	13	500
	130633	33	14,5	800
	130637	37	16	1000
	130641	41	18	1500



Colapasta conico in alluminio

Aluminium conical pasta strainer	Cod.	Ø cm
	135635	35
	135640	40
	135645	45
	135650	50





Coperchio per teglia

Lid for baking pan

Cod.	L x W cm
140530	30 x 22
140535	35 x 25
140540	40 x 28



Teglia cottura ferro blu

Blue steel baking sheet

Cod.	L x W cm	H cm
141840	30 x 40	3
141860	40 x 60	3



Teglia

Baking pan

Cod.	L x W cm	H cm
140730	30 x 22	6,5
140735	35 x 26	6,5
140740	40 x 29	7



Cod. 140740



Teglia cottura alluminio

Aluminium baking sheet

Cod.	L x W cm	H cm
142060	40 x 60	2



Placca per forno

Baking plate

Cod.	L x W cm
140940	40 x 30
140950	50 x 35
140960	60 x 40



Teglia cottura alluminio antiaderente

Baking sheet in aluminium with non stick coating

Cod.	L x W cm	H cm
142460	40 x 60	2





Mestolo unipezzo inox 18/10

Ladle one piece inox 18/10	Cod.	Ø cm	L cm	cl
	150006	6 *	31	6
	150007	7	34,5	8
	150008	8	36	12,5
	150009	9	36	19
	150010	10	43	25
	150012	12	52	50
	150014	14	55	75
	150016	16	61	100
	150018	18	64	150
	150020	20	72	200



* CON BECCO WITH BEAK



Schiumarola unipezzo inox 18/10

Skimmer one piece inox 18/10	Cod.	Ø cm	L cm
	150108	8	33,5
	150110	10	43,5
	150112	12	47,5
	150114	14	50,5
	150116	16	55,5
	150118	18	58,5
	150120	20	65,5



Forchettone a due punte unipezzo inox 18/10

Meat fork one piece inox 18/10	Cod.	L cm
	150242	42
	150253	53



Paletta con fori unipezzo inox 18/10

Perforated lifter one piece inox 18/10	Cod.	L x W cm	L cm
	150300	11 x 14	47,5



Paletta senza fori unipezzo inox 18/10

Lifter one piece inox 18/10	Cod.	L x W cm	L cm
	150400	11 x 14	47,5



Paletta per pesce unipezzo inox 18/10

Fish lifter one piece inox 18/10	Cod.	L x W cm	L cm
	150700	11 x 13	47



Cucchiaione fondo unipezzo inox 18/10

Deep spoon one piece inox 18/10	Cod.	L x W cm	L cm
	150800	11 x 7	40,5



Cucchiaione fondo manico di costa unipezzo inox 18/10

Deep side spoon one piece inox 18/10	Cod.	L x W cm	L cm
	150900	11 x 7	37



**Paletta per pesce unipezzo inox 18/10**

Fish lifter one piece inox 18/10	Cod.	L x W cm	L cm
	151000	7 x 18	37

**Cucchiaione con fori unipezzo inox 18/10**

Perforated large spoon one piece inox 18/10	Cod.	L x W cm	L cm
	151200	9,5 x 7	33,5

**Cucchiaione unipezzo inox 18/10**

Large spoon one piece inox 18/10	Cod.	L x W cm	L cm
	151100	9,5 x 7	33,5

**Schiumarola a rete saldata inox 18/10**

Mesh welded skimmer inox 18/10	Cod.	Ø cm	L cm
	152300	15	54





Mestolo unipezzo

Ladle one piece	Cod.	Ø cm	L cm	cl
	153006	6	37	6
	153008	8	39	12,5
	153010	10	45	25
	153012	12	50	50
	153014	14	54	75
	153016	16	60	100



Paletta con fori unipezzo

Perforated lifter one piece	Cod.	L x W cm	L cm
	153400	10 x 9	48



Schiumarola unipezzo

Skimmer one piece	Cod.	Ø cm	L cm
	153108	8	36
	153110	10	42
	153112	12	48
	153114	14	53
	153116	16	57



Paletta unipezzo

Lifter one piece	Cod.	L x W cm	L cm
	153401	10 x 9	48



Cucchiaione fondo unipezzo

Deep spoon one piece	Cod.	L x W cm	L cm	cl
	153800	10 x 7	47	6



Forchettone unipezzo

Meat fork one piece	Cod.	L cm
	153242	50



Cucchiaione fondo manico di costa unipezzo

Deep side spoon one piece	Cod.	L x W cm	L cm	cl
	153900	7 x 10	44	6



**Mestolo**

Ladle



Cod.

430006

Ø cm

6

**Mestolo forato**

Ladle with holes



Cod.

430106

Ø cm

6

430109

9

**Schiumarola**

Skimmer



Cod.

430200

Ø cm

11

**Mestolino ovale per salsa**

Oval sauce ladle



Cod.

430600**Schiumarola a rete**

Mesh skimmer



Cod.

430700

Ø cm

12

**Forchettone**

Meat fork

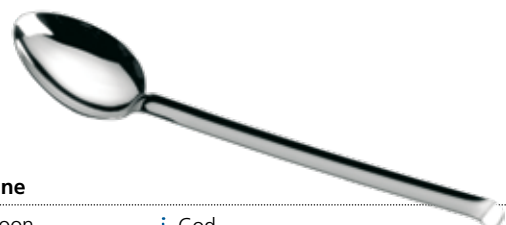

Cod.

431800**Cucchiaione**

Basting spoon

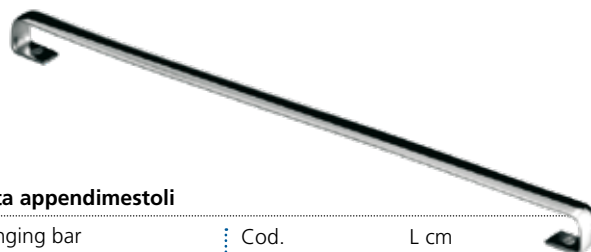

Cod.

431900**Asta appendimestoli**

Hanging bar



Cod.

432038

L cm

38

**Mestolo manico filo**

Ladle wire handle



Cod.

432309

Ø cm

9

**Schiumarola manico filo**

Skimmer wire handle



Cod.

432400

Ø cm

11

**Paletta rettangolare manico filo**

Rectang. lifter wire handle



Cod.

432500

L x W cm

7,5 x 9,5

**Forchettone manico filo**

Meat fork wire handle



Cod.

432600



Cucchiaine manico filo

Basting spoon
wire handle

Cod.
432700



Schiumarola a rete manico filo

Mesh skimmer
wire handle

Cod.
432800

Ø cm.
12



Cucchiaine policarbonato

Polycarbonate spoon

Cod.	L cm	Col.	Box
155002	34	○	12
155007	34	●	12



Cucchiaine policarbonato forato

Polycarbonate
draining spoon

Cod.
155107

L cm
34



**Cucchiaione nylon & fiberglass**

Design by Michele Capuani

Nylon & fiberglass
large spoonCod.
156000
156100L cm
38
30**Forchettone 2 punte nylon & fiberglass**

Design by Michele Capuani

Nylon & fiberglass
meat fork 2 prongsCod.
15723400L cm
34**Mestolo nylon & fiberglass
con becco a versare**

Design by Michele Capuani

Nylon & fiberglass
ladle with beakCod.
15700600Ø cm L cm cl
6 31 4**Mestolo nylon & fiberglass**

Design by Michele Capuani

Nylon & fiberglass ladle

Cod.
15700800
15701000Ø cm L cm cl
8 33 10
10 35 20**Mestolo pizza nylon & fiberglass**

Design by Michele Capuani

Nylon & fiberglass
pizza ladleCod.
15790900Ø cm L cm cl
9 35 17**Schiumarola nylon & fiberglass**

Design by Michele Capuani

Nylon & fiberglass
skimmerCod.
15711000
15711200Ø cm L cm
10 33
12 35**Cucchiaione liscio nylon & fiberglass**

Design by Michele Capuani

Nylon & fiberglass
large spoonCod.
15780000L cm
35**Cucchiaione forato nylon & fiberglass**

Design by Michele Capuani

Nylon & fiberglass
perforated large spoonCod.
15780100L cm
35

THE SPECIAL MIX NYLON & FIBERGLASS



Paletta liscia nylon & fiberglass

Design by Michele Capuani

Nylon & fiberglass lifter	Cod.	L x W cm	L cm
	15740000	9,5 x 11	35



Paletta forata nylon & fiberglass

Design by Michele Capuani

Nylon & fiberglass perforated lifter	Cod.	L x W cm	L cm
	15740100	9,5 x 11	35



Paletta hamburger nylon & fiberglass

Design by Michele Capuani

Nylon & fiberglass hamburger lifter	Cod.	L x W cm	L cm
	15740200	9 x 13	34



La nuova linea di mestolame PIAZZA nasce interamente in Italia. Lo speciale polimero con cui viene prodotta: una combinazione di nylon e fibra di vetro, ne garantisce praticità d'uso e durata nel tempo.

- **LA PARTICOLARE FORMA DEI MANICI UNISCE MASSIMA ROBUSTEZZA E GRANDE LEGGEREZZA**
- **DIMENSIONE DEI FORI DIFFERENZIATA A SECONDA DELL'UTILIZZO**
- **PERFETTAMENTE RESISTENTE AL CALORE FINO A 220°C**
- **LAVABILE IN LAVASTOVIGLIE: IGIENICITÀ GARANTITA**

PIAZZA new ladle line is fully made in Italy. It is made of a special polymer, a combination of nylon and fiberglass, that gives great guarantee of lasting in time and ease of use.

- **THE UNIQUE SHAPE OF THE HANDLES COMBINE MAXIMUM STRENGTH AND GREAT LIGHTNESS**
- **HOLES' DIMENSIONS DIVERSIFIED ACCORDING TO THE USE**
- **PERFECTLY HEAT-RESISTANT UP TO 220°C (430°F)**
- **DISHWASHER SAFE: HYGIENICALLY GUARANTEED**



**Spatola angolare**

Design by Michele Capuani

Angular spatula	Cod.	L cm
	240010	10
	240022	22
	240026	26
	240030	30
	240036	36

**Spatola angolare appuntita**

Design by Michele Capuani

Tapered point angular spatula	Cod.	L cm
	240011	11

**Spatola diritta**

Design by Michele Capuani

Spatula	Cod.	L cm
	240112	12
	240115	15
	240120	20
	240122	22
	240126	26
	240130	30
	240136	36



LE SPATOLE PROFESSIONALI: PERFETTE IN CUCINA, PIZZERIA, PASTICCERIA
 THE PROFESSIONAL SPATULAS: PERFECT FOR RESTAURANTS, PIZZERIAS, PATISSERIES

- LAMA IN ACCIAIO
- ROBUSTE, PRATICHE, FUNZIONALI
- AMPIA DISPONIBILITÀ DI FORME E DIMENSIONI: PIÙ DI 30 MODELLI
- ASOLA PER APPENDERLE PRESENTE SU TUTTA LA SERIE
- DESIGN ITALIANO
- STEEL BLADE
- STURDY, PRACTICAL, FUNCTIONAL
- WIDE RANGE OF SHAPES AND SIZES: MORE THAN 30 ITEMS
- ALL ITEMS HAVE PRACTICAL HANGING LOOPS
- ITALIAN DESIGN

**MANICO SPECIALE:
 ERGONOMICO
 E ANTISCIVOLO**

SPECIAL ERGONOMIC
 NON-SLIP HANDLE





Spatola triangolare

Design by Michele Capuani

Triangle spatula

Cod.	W x L cm
240208	8 x 12
240210	10 x 12
240212	12 x 12



Tagliapasta

Design by Michele Capuani

Dough cutter

Cod.	W x L cm
240600	16 x 12



Spatola forata

Design by Michele Capuani

Perforated spatula

Cod.	W x L cm
240300	7,5 x 16



Raschia

Design by Michele Capuani

Scraper

Cod.	W x L cm
240601	12 x 9,5
240640	15 x 7,5



Spatola per hamburger

Design by Michele Capuani

Hamburger turner

Cod.	W x L cm
240400	7 x 24
240401	14 x 19



Raschia

Design by Michele Capuani

Scraper

Cod.	W x L cm
240700	15 x 6



Spatola per pizza

Design by Michele Capuani

Pizza turner

Cod.	W x L cm
240501	9 x 15,5



Rotella tagliapizza

Design by Michele Capuani

Pizza wheel cutter

Cod.	Ø cm
241106	5,5
241110	10



Grattugia inox manico antiscivolo



UNIVERSALE ALL-IN-ONE

Stainless steel grater non slip handle

Cod.	L x W cm	L cm
160145	2,5 x 20	33



Grattugia inox manico antiscivolo



EXTRA SPESSA EXTRA COARSE

Stainless steel grater non slip handle

Cod.	L x W cm	L cm
160151	3,5 x 22	38,5



Grattugia inox manico antiscivolo



SEMI FINE MEDIUM COARSE

Stainless steel grater non slip handle

Cod.	L x W cm	L cm
160152	3,5 x 22	38,5



Grattugia inox manico antiscivolo



FINE FINE

Stainless steel grater non slip handle

Cod.	L x W cm	L cm
160153	3,5 x 22	38,5



Grattugia inox manico antiscivolo



FINE FINE

Stainless steel grater non slip handle

Cod.	L x W cm	L cm
160170	6,5 x 13,5	31,5



Grattugia inox manico antiscivolo



SPESSA COARSE

Stainless steel grater non slip handle

Cod.	L x W cm	L cm
160171	6,5 x 13,5	31,5



Grattugia inox manico antiscivolo



MEDIA RIBBON

Stainless steel grater non slip handle

Cod.	L x W cm	L cm
160172	6,5 x 13,5	31,5



Grattugia inox manico antiscivolo



SCAGLIE GRANDI LARGE SHAVER

Stainless steel grater non slip handle

Cod.	L x W cm	L cm
160173	6,5 x 13,5	31,5



Grattugia inox manico antiscivolo



ULTRA SPESSA ULTRA COARSE

Stainless steel grater non slip handle

Cod.	L x W cm	L cm
160174	6,5 x 13,5	31,5



- 9 DIFFERENTI TIPI DI LAMA PER COPRIRE OGNI ESIGENZA
- LAME IN ACCIAIO INOX CON MASSIMA EFFICACIA DI TAGLIO
- MANICO ERGONOMICO IN MATERIALE ANTISCIVOLO
- PIEDINO D'APPOGGIO IN GOMMA E CUSTODIA PARALAMA DI SICUREZZA

- 9 DIFFERENT BLADES TO FULLFILL EVERY NEED
- STAINLESS STEEL BLADES WITH FLAWLESS PRECISION
- ERGONOMIC HANDLE WITH NON-SLIP GRIP
- RUBBER FEET AND BLADE COVER FOR YOUR SAFETY



LE LAME THE BLADES

UNIVERSALE ALL-IN-ONE

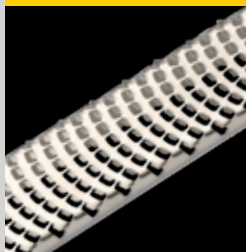

IDEALE PER:
AGRUMI,
FORMAGGIO,
ZENZERO,
CIOCCOLATO,
TARTUFO,
FRUTTA SECCA

BEST FOR:
CITRUS FRUITS,
CHEESE,
CHOCOLATE,
GINGER, TRUFFLE,
DRIED FRUIT

EXTRA SPESSE EXTRA COARSE

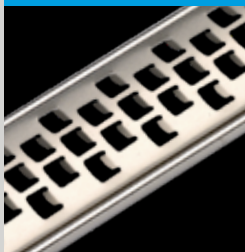

IDEALE PER:
MELE, PATATE,
BURRO,
FORMAGGIO,
ZUCCHINE,
CAROTE,
FRUTTA SECCA

BEST FOR:
APPLES, CARROTS,
POTATOES,
CHEESE, BUTTER,
ZUCCHINI,
DRIED FRUIT

SEMI FINE MEDIUM COARSE

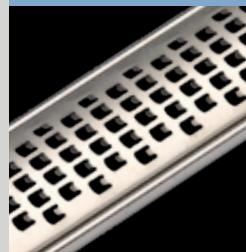

IDEALE PER:
FORMAGGIO,
ZENZERO,
PEPERONCINO,
COCCO,
CIOCCOLATO

BEST FOR:
CHEESE,
CHILI PEPPER,
GINGER,
COCONUT,
CHOCOLATE

FINE FINE

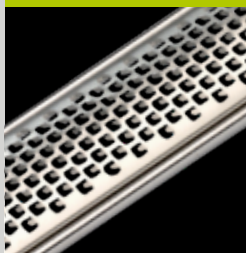

IDEALE PER:
AGRUMI,
FORMAGGIO,
AGLIO,
PEPERONCINO,
CANNELLA,
FRUTTA SECCA

BEST FOR:
CITRUS FRUITS,
CHEESE, GARLIC,
CHILI PEPPER,
CINNAMON,
DRIED FRUIT

FINE FINE



IDEALE PER:
AGRUMI,
AGLIO,
FORMAGGIO,
PEPERONCINO,
CANNELLA,
FRUTTA SECCA

BEST FOR:
CITRUS FRUITS,
CHEESE, GARLIC,
CHILI PEPPER,
CINNAMON,
DRIED FRUIT

SPESSE COARSE

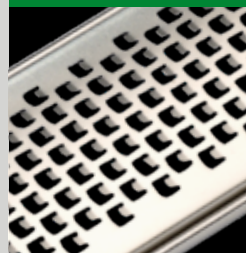

IDEALE PER:
COCCO,
CAROTE,
ZENZERO,
FRUTTA SECCA,
FORMAGGIO

BEST FOR:
CHEESE,
CARROTS,
GINGER,
COCONUT,
DRIED FRUIT

MEDIA RIBBON



IDEALE PER:
FORMAGGIO,
MELE, BURRO,
ZUCCHINE,
CAROTE,
CIOCCOLATO,

BEST FOR:
CHEESE,
CHOCOLATE,
APPLES,
CARROTS,
ZUCCHINI,
BUTTER

SCAGLIE GRANDI LARGE SHAVER



IDEALE PER:
TARTUFO,
ZUCCHINE
CIOCCOLATO,
FORMAGGIO,
BURRO

BEST FOR:
TRUFFLE,
ZUCCHINI
CHOCOLATE,
CHEESE,
BUTTER

ULTRA SPESSE ULTRA COARSE

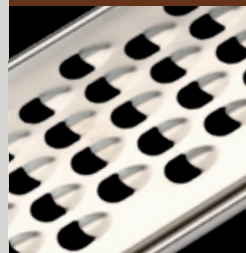

IDEALE PER:
ZUCCHINE,
BURRO,
CIOCCOLATO,
FORMAGGIO,
TARTUFO

BEST FOR:
CHEESE,
BUTTER,
ZUCCHINI,
CHOCOLATE,
TRUFFLE



Grattugia inox

Stainless steel grater	Cod.	L cm
	160109	9
	160113	13
	160116	16

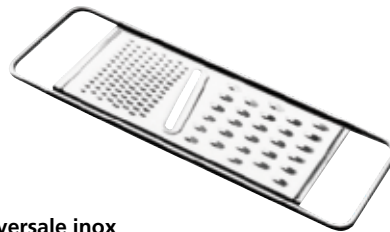

Grattugia universale inox

Stainless steel universal grater	Cod.	L x W cm
	160200	11 x 28



Grattugia quattro lati

Grater four side	Cod.	L x W cm	H cm
	160300	8 x 6	18



Frusta stagnata manico in filo

Tinned whisk, wire handle	Cod.	L cm
	160430	30
	160435	35

Termometro con protezione in filo per alimenti

Butcher's thermometer with wire cage tested for foodstuffs	Cod.	Range
	161400	-10°C - +110°C

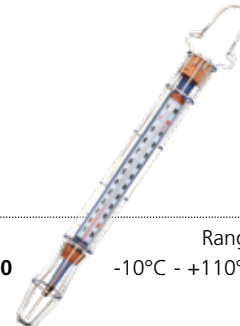

Termometro con protezione in filo per zucchero e grassi

Fat frying thermometer with wire cage	Cod.	Range
	161500	+80°C - +220°C

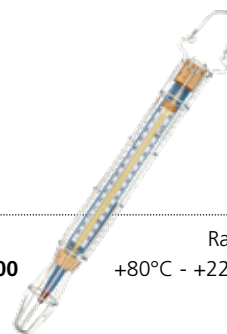

Frusta inox 8 fili professionale

Professional whisk	Cod.	L cm
	160525	25
	160530	30
	160535	35
	160540	40
	160545	45
	160550	50
	160560	60



Cod. 160525
Cod. 160535
Cod. 160540

Termometro elettronico per alimenti in cottura e surgelati

Electronic thermometer spiked stem	Cod.	Range
	161600	-35°C - +300°C



Frusta inox 8 fili professionale senza anello

Professional whisk without ring	Cod.	L cm
	160630	30



Termometro elettronico a penna multifunzionale

Electronic thermometer pointed stainless steel stem	Cod.	Range
	161700	-50°C - +200°C





Guanto super rinforzato

Extra reinforced gloves Cod. Range
161800 fino a 240°C



Coppia guanti rinforzati

Professional reinforced gloves Cod. Range
161900 fino a 180°C



Coppia manopole da forno polso lungo in pelle ovina

Pair of professional reinf. gloves in kid leather Cod. Range
162001 fino a 250°C



Schiumarola stagnata manico filo e piattina

Tinned skimmer Cod. Ø cm
162014 14
162016 16
162018 18
162020 20
162024 24



Forchettone stagnato a 3 punte

Tinned fork Cod. L cm
162140 40
162160 60



Colabrodo stagnato doppia rete manico in legno

Tinned strainer double wire net wooden handle Cod. Ø cm
162220 20
162223 23
162226 26



Schiumarola inox manico filo e piattina

Wire skimmer stainless steel Cod. Ø cm
162516 16
162518 18
162520 20
162524 24



Colabrodo stagnato doppia rete rinforzato manico in legno

Tinned strainer double wire net reinforced wooden handle Cod. Ø cm
162323 23
162326 26
162330 30
162335 35



Riga limone

Lemon grater

Cod.	L cm
163400	14



Decora limone

Lemon decorator

Cod.	L cm
163500	14,5



Coltello per pelare

Peeling knife

Cod.	L cm
163600	14,5



Sbuccia arancia

Orange peeler

Cod.	L cm
163700	14,5



Levator solo

Apple corer

Cod.	L cm
163800	17,5



Arriccia burro

Butter-curler

Cod.	L cm
163900	16



Coltello per pelare

Peeling knife

Cod.	L cm
164000	21



Scavino 2 coppe

Melon baller-double

Cod.	L cm
164100	16,5



Scavino 1 coppa

Melon baller

Cod.	L cm
164200	13





**Pinza per crostacei
in alluminio pressofuso**

Shellfish scissors
in die-cast aluminium

Cod. **164300**

L cm
14



**Snocciolatore per olive
in alluminio pressofuso**

Olive stoner in die-cast
aluminium

Cod. **164900**

L cm
18,5



Sbucciaverdure ad archetto

Vegetable peeler

Cod. **164400**

L cm
12,5



Pelasparagi in alluminio pressofuso

Asparagus peeler
in die-cast aluminium

Cod. **165000**

L cm
12



**Decora-rapanelli e decora-agrumi
in alluminio pressofuso**

Radish and citrus decorator
in die-cast aluminium

Cod. **164600**

L cm
18



Squamapesci in alluminio pressofuso

Fish scaler in die-cast
aluminium

Cod. **165100**

L cm
20



**Decoratore multiuso
in alluminio pressofuso**

Multipurpose decorator
in die-cast aluminium

Cod. **164700**

L cm
15



**Pinza per crostacei con pinzette
in alluminio pressofuso**

Shellfish scissors with tongs
in die-cast aluminium

Cod. **165200**

L cm
21



**Tagliauova per fette rotonde
ed ovali in alluminio pressofuso**

Round and oval shaped
egg slicer in die-cast
aluminium

Cod. **164801**

L cm
12





Batticarne a pugno inox

Solid stainless steel meat beater	Cod.	W kg
	165310	1
	165315	1,5
	165320	2
	165325	2,5



Gancio girevole inox

Swivel stainless steel hook with balls on both sides	Cod.	L x W mm	Box
	165621	210 x 9	15
	165624	240 x 10	15
	165627	270 x 12	15
	165650	500 x 12	15



Batticarne a due tagli inox

Stainless steel meat beater - 2 cuts	Cod.	W kg
	165400	1,1



Gancio fisso una punta inox

Standard stainless steel hook 1 point	Cod.	L x W mm	Box
	165706	60 x 3	100
	165808	80 x 4	50
	165810	100 x 4	50
	165912	120 x 5	10
	165914	140 x 5	10
	166016	160 x 6	10
	166018	180 x 6	10
	166218	180 x 8	10
	166530	300 x 12	5



Batticarne a paletta inox

Stainless steel round ladle-type meat beater with bent handle	Cod.	W kg
	165500	1



Gancio ad ancora inox 1 punta

Stainless steel anchor-type hook 1 point	Cod.	L x W mm	Box
	166707	130 x 7	10





Spiedini inox

Stainless steel skewer	Cod.	L x W mm	Box
	166820	200 x 3	6
	166825	250 x 3	6
	166830	300 x 3	6
	166920	200 x 4	6
	166925	250 x 4	6
	166930	300 x 4	6

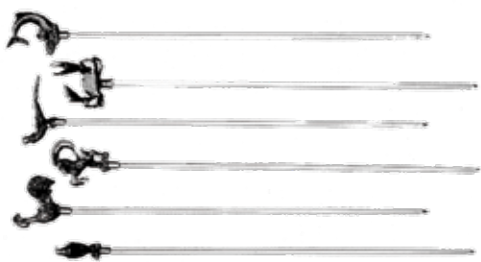

Set di spiedini inox con decoro animale

Set of stainless steel skewers with animal decoration	Cod.	L x W mm
	167000	300 x 30



Morsa prosciutto base in legno

Ham vice	Cod.
	167300



Ceppo inox con piano in plastica piedini inox antiscivolo

Stainless steel chopping block with plastic top	Cod.	L x W cm	H cm
	167440	40 x 40	90
	167450	50 x 50	90
	167460	60 x 60	90



Sega per ossa inox fissaggio rapido

Stainless steel saw, quick-fit	Cod.	L cm	Box
	167145	45	3
	167150	50	3
	167155	55	3



Guanto di protezione inox 5 dita

Stainless steel glove	Cod.
	167600



Ricambio lama sega per ossa fiss. rapido

Saw blade	Cod.	L cm	Box
	167240	40	3
	167245	45	3
	167250	50	3
	167255	55	3





**Portavivande per frigorifero
(senza coperchio)**

Food carrier (lid not included)	Cod.	L x W cm	H cm
	170000	9,5 x 9,5	6
	170200	9,5 x 19,5	6
	170400	19,5 x 19,5	6
	170600	20 x 29	7



Mandolina con carrello

Professional vegetable cutter with safety guard	Cod.
	195100



Coperchio per portavivande per frigorifero

Lid for food carrier	Cod.	L x W cm	Per/For
	170100	9,5 x 9,5	170000
	170300	9,5 x 19,5	170200
	170500	19,5 x 19,5	170400
	170700	20 x 29	170600



Set lame per mandolina 195100

Blades for vegetable cutter 195100	Cod.
	195600



Mandolina affetta verdure

Professional vegetable cutter	Cod.
	195200



**Platto espositore
per pasticceria e gastronomia**

Display tray	Cod.	L x W cm	H cm
	180114	14,5 x 21	2
	180129	29 x 21	2
	180158	58 x 21	2



Carrello per mandolina

Safety guard	Cod.
	195300





Mandolina "gourmet"

Manual vegetable slicer Cod. 195400



Affettapane con tagliere in legno

Bread cutter with wood Cod. 196200



Confezione 4 lame per mandolina "gourmet"

Set of 4 blades for "gourmet" manual vegetable slicer Cod. 195500



Coltello pane con base in legno

Bread cutter Cod. 196300



Affettaverdure rotante "le rouet"

Rotating vegetable slicer "le rouet" Cod. 195700



Grattugia fine

Grater Cod. 196500



Scavino pulisci pomodoro

Tomato seeds remover Cod. 195900





Coltello cuoco

Chef knife	Cod.	L cm
	8115-1461F12	15
	8115-1461F05	21
	8115-1461F60	23
	8115-1461F61	25



Coltello trinciante

Carving knife	Cod.	L cm
	8115-1461F04	21
	8115-1461F57	25



Coltello filettare

Fillet knife	Cod.	L cm
	8115-1461F09	18



Coltello multiuso

Utility knife	Cod.	L cm
	8115-1461F03	13



Coltello multiuso lama larga

Utility knife	Cod.	L cm
	8115-1461F70	14



Spelucchino

Paring knife	Cod.	L cm
	8115-1461F01	9



Spelucchino lama curva

Curved paring knife	Cod.	L cm
	8115-1461F17	8



LA TRADIZIONE ORIENTALE NEL TRATTAMENTO DELLE LAME SI UNISCE ALLA ROBUSTEZZA DELL'ACCIAIO TEDESCO
ORIENTAL TRADITION IN THE TREATMENT OF BLADE JOINS THE STRENGTH OF GERMAN STEEL

PREMIUM SERIES COLTELLI FORGIATI
FORGED KNIVES



L'acciaio dei coltelli Atlantic Chef è acciaio tedesco 1.4116-X50 Cr Mo V15. La combinazione di Carbonio, Cromo, Molibdeno, Vanadio e altri materiali, conferisce alla lama una durezza di HRC 56' e oltre, fornendo rigidità ed elasticità al tempo stesso, aumentando la resistenza alla corrosione e ottimizzando l'efficacia di taglio. La levigatura manuale garantisce infine la lunga durata del filo della lama, una facile manutenzione e una veloce riaffilatura.

I coltelli Atlantic Chef sono inoltre tutti certificati NSF® International.

PER GARANTIRE RESISTENZA E DURATA NEL TEMPO, MANICO E LAMA SONO FORGIATI A PARTIRE DA UN UNICO PEZZO DI ACCIAIO. CIÒ FORNISCE INOLTRE A OGNI SINGOLO PEZZO UNA BILANCIATURA PERFETTA CHE NE FACILITA L'UTILIZZO E RIDUCE LA FATICA.

HANDLE AND BLADE ARE FORGED FROM A SINGLE PIECE OF STEEL, WHICH PROVIDES STRENGTH AND A LONG USEFUL LIFE. ADDITIONALLY, EACH KNIFE IS PERFECTLY BALANCED: THIS HELPS ITS EASY USE AND REDUCES EFFORT.

MANICI IN DUPONT™ DELRIN® POM, UNA RESINA ACETALICA CON CARATTERISTICHE UNICHE DI RIGIDITÀ E RESISTENZA AGLI URTI RIPETUTI, ALL'ABRASIONE E ALL'UMIDITÀ. SONO PERFETTAMENTE ADERENTI AL MANICO E AI RIVETTI, OFFRENDO MASSIMA IGIENICITÀ.

HANDLES ARE MADE OF DUPONT™ DELRIN® POM, AN ACETAL RESIN FEATURING UNIQUE CHARACTERISTICS OF STIFFNESS AND RESISTANCE TO REPEATED SHOCKS, ABRASION AND HUMIDITY. THEY PERFECTLY STICK TO THE HANDLE AND RIVETS, ASSURING TOP HYGIENE.



Coltello Santoku

Santoku knife Cod. L cm
8115-1461F38 18



Coltello arrosto

Slicing knife Cod. L cm
8115-1461F109 28



Coltello Usuba

Usuba knife Cod. L cm
8115-1461F46 18



Forchettone curvo

Carving fork - curved Cod. L cm
8115-1461F11 16



Coltello disosso

Boning knife Cod. L cm
8115-1461F10 15



Coltello pane

Bread knife Cod. L cm
8115-1461F06 21
8115-1461F53 23



Coltello pomodoro lama dentata

Tomato knife - serrated edge Cod. L cm
8115-1461F14 14



EFFICIENT SERIES COLTELLI STAMPATI
STAMPED KNIVES



Atlantic Chef uses German Steel 1.4116-X50 Cr Mo V15, which consists of Carbon, Chromium, Vanadium, Molybdenum and several other materials. After hardening/tempering, grinding, sharpening and some other major processes, the hardness of the blades can reach as high as HRC 56' and above. Knives are simultaneously strong and flexible, and this increases their cutting power and resistance to corrosion. The hand-honed razor sharp blade edge also offers long lasting sharpness, easy edge maintenance and rapid re-sharpening features. All the knives are certified by NSF® International.

GRAZIE A PROCESSI PRODUTTIVI AVANZATI E DI MASSIMA PRECISIONE, L'ACCOPIAMENTO FRA MANICO E LAMA RISULTA SEMPRE PERFETTAMENTE COMPATTO, GARANTENDO IGIENE E SOLIDITÀ OTTIMALI.

THANKS TO ADVANCED AND PRECISE PRODUCTIVE PROCESSES THE JOINING BETWEEN HANDLE AND BLADE ARE ALWAYS PERFECT AND SOLID.

I MANICI SONO REALIZZATI CON LA COMBINAZIONE DI SANTOPRENE® (UNO SPECIALE ELASTOMERO DALLE DOTI ANTISCIVOLO) E POLIPROPILENE. OFFRONO PRESA SICURA, TOTALE CONTROLLO DEL COLTELLO E MASSIMA ROBUSTEZZA.

THE HANDLES, MADE BY A COMBINATION OF SANTOPRENE® (A SPECIAL ELASTOMER WITH NON-GRIP FEATURES) AND POLYPROPYLENE, OFFER NON-SLIP ERGONOMIC GRIP, TOTAL CONTROL OF THE KNIFE AND MAXIMUM STRENGTH.



Coltello cuoco

Chef knife



Cod.	L cm	Col.
8100-8321T12	15	●
8100-8321T05	21	●
8100-8321T05BL	21	●
8100-8321T05G	21	●
8100-8321T05R	21	●
8100-8321T05W	21	○
8100-8321T05Y	21	●
8100-8321T60	23	●
8100-8321T61	25	●
8100-8321T61BL	25	●
8100-8321T61BR	25	●
8100-8321T61G	25	●
8100-8321T61R	25	●
8100-8321T61W	25	○
8100-8321T61Y	25	●
8100-8321T62	30	●
8100-8321T62BL	30	●
8100-8321T62BR	30	●
8100-8321T62G	30	●
8100-8321T62R	30	●
8100-8321T62W	30	○
8100-8321T62Y	30	●



PER ALCUNI SPECIFICI MODELLI È PREVISTA LA DISPONIBILITÀ ANCHE DI MANICI COLORATI IN ACCORDO CON LA NORMATIVA HACCP

SOME SPECIFIC ITEMS ARE AVAILABLE ALSO WITH COLOURED HANDLES ACCORDING TO HACCP REGULATIONS



Coltello multiuso

Utility knife

Cod.	L cm
8100-8321T70	15



Coltello multiuso lama dentata

Utility knife
Serrated edge

Cod.	L cm
8150-8321SS132	13



Coltello filettare - flessibile

Fillet knife - flexible

Cod.	L cm	Col.
8100-8321T09	18	●
8100-8321T71	21	●
8100-8321T71BL	21	●



Coltello cuoco lama dentata

Chef knife
Serrated edge

Cod.	L cm
8100-8321T137	21
8100-8321T143	23
8100-8321T144	25



Coltello Santoku

Santoku knife

Cod.	L cm
8100-8321T38	19



Coltello cuoco lama obliqua

Wide chef knife

Cod.	L cm
8100-8321T115	21



Coltello Usuba

Usuba knife

Cod.	L cm
8100-8321T46	18



**Coltello disosso**

Boning knife

Cod.	L cm	Col.
8100-8321T10	15	●
8100-8321T10BL	15	●
8100-8321T10R	15	●
8100-8321T10Y	15	●

**Spelucchino**

Paring knife

Cod.	L cm	Col.
8150-8321SS01	8	●
8150-8321SS01G	8	●
8150-8321SS01W	8	○
8150-8321SS02	11	●

**Coltello disosso - Flessibile**

Boning knife - Flexible

Cod.	L cm
8100-8321T66	15

**Spelucchino lama dentata**Paring knife
serrated edge

Cod.	L cm	Col.
8150-8321SS36	8	●
8150-8321SS36G	8	●
8150-8321SS36W	8	○

**Coltello disosso stretto**

Wide boning knife

Cod.	L cm
8100-8321T133	13

**Spelucchino verdure lama curva**

Curved paring knife

Cod.	L cm	Col.
8150-8321SS17	7	●
8150-8321SS17G	7	●
8150-8321SS17W	7	○

**Coltello disosso stretto - Flessibile**Narrow boning knife
Flexible

Cod.	L cm
8100-8321T69	15

**Coltello tavola**

Utility knife - Round top

Cod.	L cm	Col.
8150-8321SS03	11	●
8150-8321SS03G	11	●
8150-8321SS03W	11	○

**Coltello disosso curvo**

Curved boning knife

Cod.	L cm
8100-8321T64	15

**Coltello arrosto**

Slicer knife

Cod.	L cm
8100-8321T136	23





Forchettone curvo

Carving fork - Curved
Cod. L cm
8100-8321T11 21



Forchettone diritto

Carving fork - Straight
Cod. L cm
8100-8321T28 18



Coltello salmone

Salmon knife
Cod. L cm
8100-8321T19 26



Coltello salmone lama alveolata

Salmon knife
granton edge
Cod. L cm
8100-8321T77 26



Coltello prosciutto

Slicing knife
Cod. L cm
8100-8321T108 30



Coltello prosciutto lama alveolata

Slicing knife
granton edge
Cod. L cm Col.
8100-8321T73 28 ●
8100-8321T73W 28 ○
8100-8321T68 36 ●



Coltello formaggio punta quadra

Cheese slicer
Cod. L cm
8100-8321T135 31



Coltello pane

Bread knife
Cod. L cm Col.
8100-8321T06 21 ●
8100-8321T06W 21 ○
8100-8321T134 25 ●



Coltello pane con scalino

Offset bread knife
Cod. L cm
8100-8321T15 21



Coltello pane con scalino e punta arrotondata

Offset bread knife
Round top
Cod. L cm
8100-8321T106 21



Coltello pane lama inclinata

Wide bread knife
Cod. L cm
8100-8321T59 25



Coltello panettiere

Slicing knife
Serrated edge
Cod. L cm Col.
8100-8321T72 28 ●
8100-8321T72W 28 ○
8100-8321T100 30 ●
8100-8321T101 36 ●





Coltello dolce

Cake knife	Cod.	L cm
	8100-8320T30	40
	8100-8320T31	45



Forbici

Scissors	Cod.
	8155-9300T01



Coltello dolce lama dentata

Cake knife Serrated edge	Cod.	L cm
	8100-8320T32	40
	8100-8320T40	45



Custodia

Knife guard	Cod.	Per/For
	8190-8321SS02	8150-8321SS02
	8190-8321SS132	8150-8321SS132
	8190-8321SS17	8150-8321SS17
	8190-8321T09	8100-8321T09
	8190-8321T100	8100-8321T100
	8190-8321T133	8100-8321T133
	8190-8321T134	8100-8321T134
	8190-8321T135	8100-8321T135
	8190-8321T136	8100-8321T136
	8190-8321T60	8100-8321T60



Set decorazione cocktail - 7 pezzi

Cocktail decoration set 7 pieces	Cod.
	8151-9100G7001



Acciaio tondo

Sharpening steel	Cod.	L cm
	8153-TD1312	30



Set per intaglio e decorazione - 8 pezzi

Carving tool set 8 pieces	Cod.
	8151-9100G8001



Affilacoltelli manuale

Hand held knife sharpener	Cod.
	8154-SH001





Coltello forgiato per pelare

Forged paring knife	Cod.	L cm
	205100	10



Coltello forgiato per cucina

Forged cook's knife	Cod.	L cm
	206015	15
	206020	20
	206025	25



Coltello forgiato per pane

Forged bread knife	Cod.	L cm
	205400	20



Coltello forgiato per cucina

Forged cook's knife	Cod.	L cm
	206330	30



Coltello forgiato per arrosti

Forged filleting knife	Cod.	L cm
	205500	18



Apriostriche forgiato

Forged oyster opener	Cod.
	206200



Coltello forgiato per salmone

Forged salmon knife	Cod.	L cm
	205700	32

MASSIMA EFFICACIA E IGIENE PERFETTA
MAX EFFICIENCY AND PERFECT HYGIENE

I taglieri in Polietilene HD sono adatti a tutti gli ambiti HACCP.
Grazie alla loro superficie, totalmente liscia, e alla totale assenza di coloranti garantiscono massima efficacia d'uso e perfetta igiene.
Nella confezione inoltre sono compresi 7 fermi e 5 viti di montaggio per classificare a vostro piacere l'utilizzo del tagliere secondo la normativa HACCP.

These HD polyethylene cutting boards are suitable for all HACCP areas.

Max efficiency and perfect hygiene guaranteed thanks to the super smooth surface and total absence of colouring.

Each pack also contains 7 coloured stoppers and 5 screws letting you colour code each board for use in a specific HACCP area.



1
MONTARE IL PRIMO FERMO (SEMPRE BIANCO)

INSERT THE FIRST STOPPER (ALWAYS WHITE)



2
MONTARE IL SECONDO FERMO (COLORE HACCP)

INSERT THE SECOND STOPPER (HACCP COLOUR)



Tagliere in polietilene HD

Polyethylene cutting board	Cod.	L x W cm	H cm
	208000	40 x 30	2
	208100	50 x 30	2
	208200	50 x 40	2
	208300	60 x 40	2
	208400	70 x 40	2



209000



209099

Pialletto e fermi per taglieri in polietilene

Scraper and stoppers for polyethylene cutting boards	Cod.	Box
	209000	6
	209099	6



Cod. 209099

CARNI CRUDE RAW MEAT	PANE E FORMAGGI BREAD AND CHEESE	CARNI COTTE COOKED MEAT	INSALATA E FRUTTA VEGETABLES AND FRUITS	VERDURE COTTE COOKED VEGETABLES	PESCE FISH



MAX. MM 146

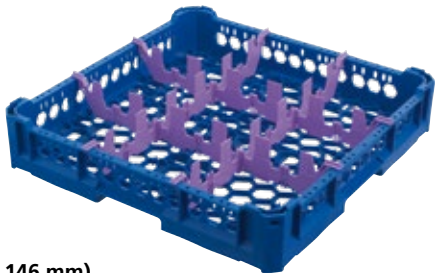
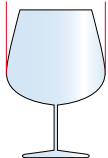

Cestello bicchieri a 9 scomparti (146 x 146 mm)

Glass rack with 9 compartments (146 x 146 mm)	Cod.	L x W cm	H mm	Box
	210000	50 x 50	< 65	2
	210001	50 x 50	66-120	
	210002	50 x 50	121-250	
	210003	50 x 50	251-340	



MAX. MM 88



Cestello bicchieri a 25 scomparti (88 x 88 mm)

Glass rack with 25 compartments (88 x 88 mm)	Cod.	L x W cm	H mm	Box
	210020	50 x 50	< 65	2
	210021	50 x 50	66-120	
	210022	50 x 50	121-250	
	210023	50 x 50	251-340	



MAX. MM 113

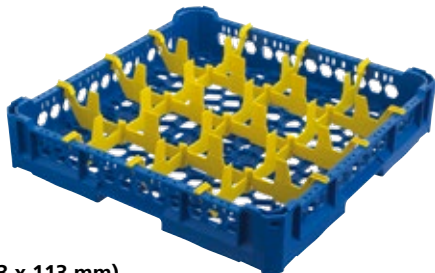
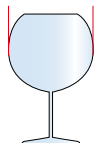

Cestello bicchieri a 16 scomparti (113 x 113 mm)

Glass rack with 16 compartments (113 x 113 mm)	Cod.	L x W cm	H mm	Box
	210010	50 x 50	< 65	2
	210011	50 x 50	66-120	
	210012	50 x 50	121-250	
	210013	50 x 50	251-340	



MAX. MM 73



Cestello bicchieri a 36 scomparti (73 x 73 mm)

Glass rack with 36 compartments (73 x 73 mm)	Cod.	L x W cm	H mm	Box
	210030	50 x 50	< 65	2
	210031	50 x 50	66-120	
	210032	50 x 50	121-250	
	210033	50 x 50	251-340	



PERSONALIZZAZIONE FACILE E VELOCE
QUICK AND EASY PERSONALISING

I cestelli bicchieri consentono una facile e veloce personalizzazione, adattandosi alle vostre esigenze di lavaggio. La presenza di elementi scorrevoli all'interno delle guide fissate ai quattro angoli permette di variare l'altezza totale del cestello.

Basta sollevare l'elemento superiore (l'estensione con la griglia a scomparti) fino all'altezza desiderata. (Fig.1)

Inserite i 4 bottoni di fissaggio in dotazione per bloccare i cursori di scorrimento e fissare l'estensione. (Fig. 2)

Il cestello è pronto per essere riempito con i bicchieri da mandare in lavaggio. (Fig. 3)

Se una volta ultimato il processo di lavaggio necessitate una diversa altezza del cestello non dovete fare altro che rimuovere (e sostituire) i bottoni di fissaggio, i cursori saranno nuovamente liberi di scorrere permettendovi una differente personalizzazione dell'altezza del cestello.

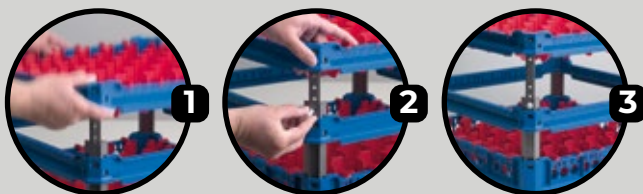

These glass racks can be quickly and easily personalised, letting you adapt to your specific needs each time. Special elements running inside the fixed guides at the four corners let you change the total height of your rack whenever necessary.

Simply lift the top element (extender with divider insert) to the height you want. (Fig. 1)

Insert the 4 fixing buttons provided to stop the sliders and so fix the extender. (Fig. 2)

Your rack is ready to be filled with glasses to be washed. (Fig. 3)

If, after washing, you need to change the height for other glasses, simply remove (and replace) the buttons: the sliders are now freed for you to adjust the height (insert the buttons at the new height).

MAX. MM 63

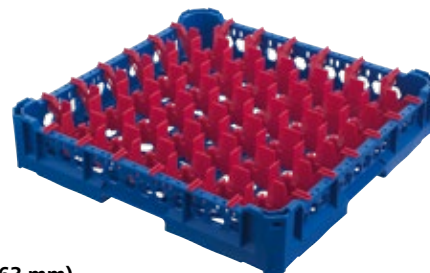

Cestello bicchieri a 49 scomparti (63 x 63 mm)

Glass rack with 49 compartments (63 x 63 mm)	Cod.	L x W cm	H mm	Box
	210040	50 x 50	< 65	2
	210041	50 x 50	66-120	
	210042	50 x 50	121-250	
	210043	50 x 50	251-340	



1

• CESTELLO BASE 50X50 CM CON GRIGLIA A 9-16-25-36-49 SCOMPARTI
• 50X50 CM RACK BASE AND DIVIDER INSERT WITH 9-16-25-36-49 COMPART

2

• CESTELLO BASE 50X50 CM CON GRIGLIA A 9-16-25-36-49 SCOMPARTI
• ESTENSIONE 50X50 CM CON GRIGLIA A 9-16-25-36-49 SCOMPARTI
• 50X50 CM RACK BASE AND DIVIDER INSERT WITH 9-16-25-36-49 COMPART
• 50X50 CM EXTENDER AND DIVIDER INSERT WITH 9-16-25-36-49 COMPART

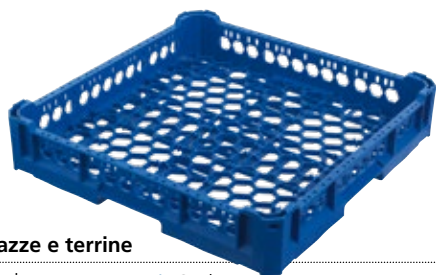

Cestello tazze e terrine

Cup/pan rack Cod. L x W cm Box
 211000 50 x 50 2



Cestello vassoi aperto

Open tray rack Cod. L x W cm Box
 211003 50 x 50 2



Cestello piatti-vassoi

Plate/tray rack Cod. L x W cm Box
 211001 50 x 50 2

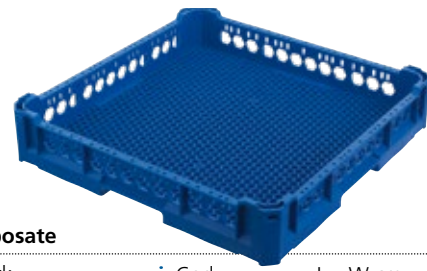

Cestello posate

Cutlery rack Cod. L x W cm Box
 211004 50 x 50 2



Cestello vassoi

Tray rack Cod. L x W cm Box
 211002 50 x 50 2



Carrello per cestelli

Rack trolley Cod. 219000



CONFEZIONE
 20
 PEZZI/PIECES

Bottoni fissaggio di ricambio

Spare fixing buttons Cod. 219900



UNICO CESTELLO, DIFFERENTI SOLUZIONI

SINGLE RACK, DIFFERENT SOLUTIONS

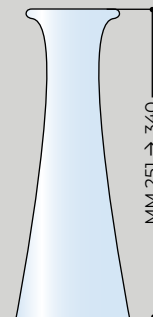
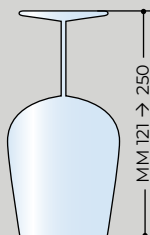

- CESTELLO BASE 50X50 CM CON GRIGLIA A 9-16-25-36-49 SCOMPARTI
- ESTENSIONE 50X50 CM CON GRIGLIA A 9-16-25-36-49 SCOMPARTI
- BOTTONI PER FISSAGGIO
- 50X50 CM RACK BASE AND DIVIDER INSERT WITH 9-16-25-36-49 COMPART
- 50X50 CM EXTENDER AND DIVIDER INSERT WITH 9-16-25-36-49 COMPART
- FIXING BUTTONS

- CESTELLO BASE 50X50 CM CON GRIGLIA A 9-16-25-36-49 SCOMPARTI
- ESTENSIONE 50X50 CM CON GRIGLIA A 9-16-25-36-49 SCOMPARTI
- ESTENSIONE APERTA 50X50 CM
- BOTTONI PER FISSAGGIO
- 50X50 CM RACK BASE AND DIVIDER INSERT WITH 9-16-25-36-49 COMPART
- 50X50 CM EXTENDER AND DIVIDER INSERT WITH 9-16-25-36-49 COMPART
- OPEN 50X50 CM EXTENDER
- FIXING BUTTONS

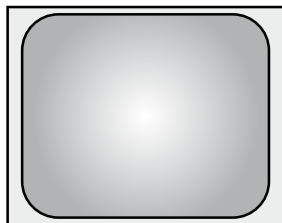

Bacinella GN 2/1 in acciaio inox

Gastronorm container 2/1 in stainless steel	Cod.	L x W cm	H cm
	220002	65 x 53	2
	220004	65 x 53	4
	220006	65 x 53	6,5
	220010	65 x 53	10
	220015	65 x 53	15
	220020	65 x 53	20

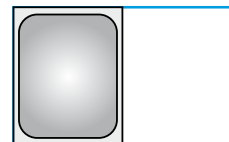

Bacinella GN 1/2 in acciaio inox

Gastronorm container 1/2 in stainless steel	Cod.	L x W cm	H cm
	220302	32,5 x 26,5	2
	220304	32,5 x 26,5	4
	220306	32,5 x 26,5	6,5
	220310	32,5 x 26,5	10
	220315	32,5 x 26,5	15
	220320	32,5 x 26,5	20



Bacinella GN 1/1 in acciaio inox

Gastronorm container 1/1 in stainless steel	Cod.	L x W cm	H cm
	220102	53 x 32,5	2
	220104	53 x 32,5	4
	220106	53 x 32,5	6,5
	220110	53 x 32,5	10
	220115	53 x 32,5	15
	220120	53 x 32,5	20

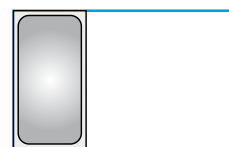

Bacinella GN 1/3 in acciaio inox

Gastronorm container 1/3 in stainless steel	Cod.	L x W cm	H cm
	220402	32,5 x 17,5	2
	220404	32,5 x 17,5	4
	220406	32,5 x 17,5	6,5
	220410	32,5 x 17,5	10
	220415	32,5 x 17,5	15
	220420	32,5 x 17,5	20

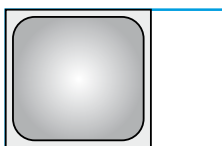

Bacinella GN 2/3 in acciaio inox

Gastronorm container 2/3 in stainless steel	Cod.	L x W cm	H cm
	220202	35,5 x 32,5	2
	220204	35,5 x 32,5	4
	220206	35,5 x 32,5	6,5
	220210	35,5 x 32,5	10
	220215	35,5 x 32,5	15
	220220	35,5 x 32,5	20

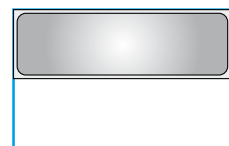

Bacinella GN 2/4 in acciaio inox

Gastronorm container 2/4 in stainless steel	Cod.	L x W cm	H cm
	222904	53 x 16,2	4
	222906	53 x 16,2	6,5
	222910	53 x 16,2	10
	222915	53 x 16,2	15

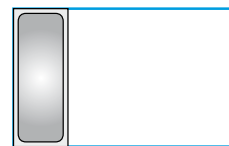

Bacinella GN 2/8 in acciaio inox

Gastronorm container 2/8 in stainless steel	Cod.	L x W cm	H cm
	224015	13 x 32,5	15

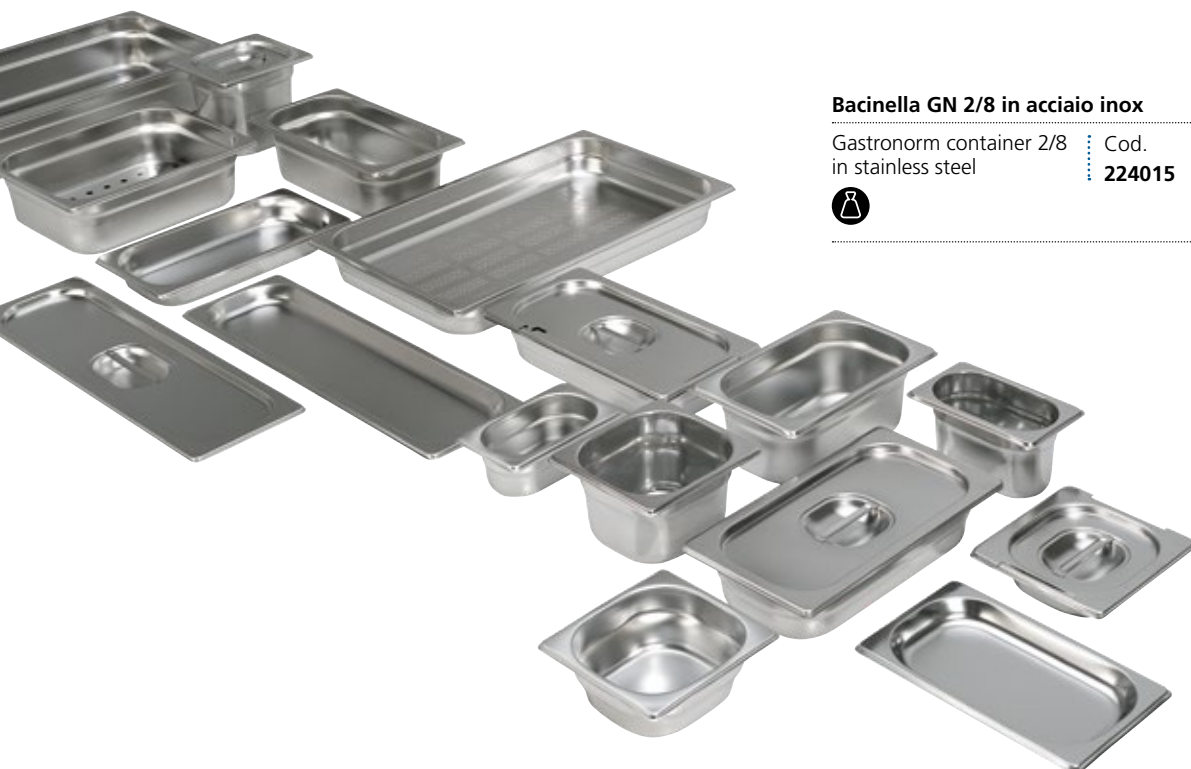

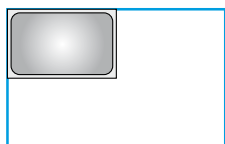

Bacinella GN 1/4 in acciaio inox

Gastronorm container 1/4 in stainless steel	Cod.	L x W cm	H cm
	220502	26,4 x 16,2	2
	220504	26,4 x 16,2	4
	220506	26,4 x 16,2	6,5
	220510	26,4 x 16,2	10
	220515	26,4 x 16,2	15
	220520	26,4 x 16,2	20

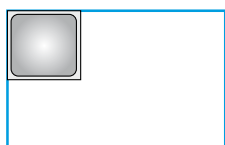

Bacinella GN 1/6 in acciaio inox

Gastronorm container 1/6 in stainless steel	Cod.	L x W cm	H cm
	220602	17,6 x 16,2	2
	220604	17,6 x 16,2	4
	220606	17,6 x 16,2	6,5
	220610	17,6 x 16,2	10
	220615	17,6 x 16,2	15
	220620	17,6 x 16,2	20

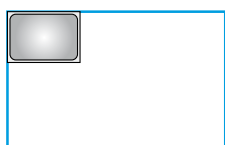

Bacinella GN 1/9 in acciaio inox

Gastronorm container 1/9 in stainless steel	Cod.	L x W cm	H cm
	220706	17,6 x 10,8	6,5
	220710	17,6 x 10,8	10



PREPARARE, CUOCERE, TRASPORTARE ED ESPORRE
PREPARE, COOK, TRANSPORT AND DISPLAY

Potete fare tutto utilizzando il medesimo contenitore evitando scomode sostituzioni.

La serie in acciaio inox 18/10 è adatta a qualunque tipo di preparazione sia a caldo che a freddo e le sue caratteristiche tecniche ne consentono l'uso in tutte le moderne apparecchiature professionali: friggitrice, forni di cottura, armadi frigoriferi ecc. Totalmente idonea al contatto con gli alimenti, secondo la normativa UE89/109, garantisce una perfetta igienicità grazie anche alla semplicità di pulizia (può andare in lavastoviglie).

You can do everything using the same container, avoiding bothersome replacements.

The series in 18/10 stainless steel is ideal for all kinds of hot and cold preparations and its technical features mean that the series can be used with all modern professional equipment: fryers, cooking ovens, refrigerated units etc. Fully suitable for contact with foodstuffs in accordance with UE89/109 Standards, it ensures perfect hygiene, thanks also to easy cleaning (it can go in the dishwasher).

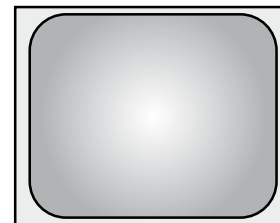

Teglia GN 2/1 in acciaio inox

Gastronorm baking pan 2/1 in stainless steel	Cod.	L x W cm	H cm
	223002	65 x 53	2
	223004	65 x 53	4
	223006	65 x 53	6,5

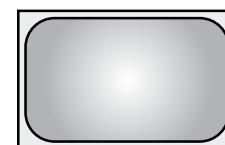

Teglia GN 1/1 in acciaio inox

Gastronorm baking pan 1/1 in stainless steel	Cod.	L x W cm	H cm
	220802	53 x 32,5	2
	220804	53 x 32,5	4
	220806	53 x 32,5	6,5

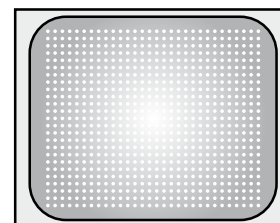

Bacinella forata GF 2/1 in acciaio inox

Gastronorm perforated container 2/1 in stainless steel	Cod.	L x W cm	H cm
	220902	65 x 53	2
	220904	65 x 53	4
	220906	65 x 53	6,5
	220910	65 x 53	10
	220915	65 x 53	15
	220920	65 x 53	20

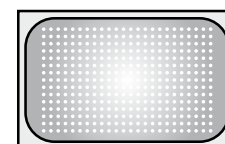

Bacinella forata GF 1/1 in acciaio inox

Gastronorm perforated container 1/1 in stainless steel	Cod.	L x W cm	H cm
	221002	53 x 32,5	2
	221004	53 x 32,5	4
	221006	53 x 32,5	6,5
	221010	53 x 32,5	10
	221015	53 x 32,5	15
	221020	53 x 32,5	20

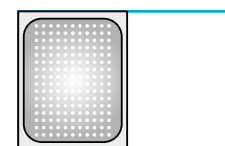

Bacinella forata GF 1/2 in acciaio inox

Gastronorm perforated container 1/2 in stainless steel	Cod.	L x W cm	H cm
	221102	32,5 x 26,5	2
	221104	32,5 x 26,5	4
	221106	32,5 x 26,5	6,5
	221110	32,5 x 26,5	10
	221115	32,5 x 26,5	15
	221120	32,5 x 26,5	20





Falso fondo forato

Gastronorm drainer plate	Cod.	GN
	221611	1/1
	221612	1/2
	221621	2/1
	221623	2/3



Coppia maniglie cascanti

Falling handles	Cod.
	221800



LA COPPIA MANIGLIE CASCANTI VIENE VENDUTA SOLTANTO IN COMBINAZIONE CON LA RELATIVA BACINELLA GASTRONORM. IL COSTO DELLE MANIGLIE È DA SOMMARSÌ AL COSTO DELLA BACINELLA.

TWO FALLING HANDLES ARE SOLD ONLY AS SET WITH THE CORRESPONDING GN FOODCONTAINER. HANDLE-PRICE HAS TO BE ADDED TO THE CONTAINER-PRICE.



Separatore

Adaptor bar	Cod.	L cm
	221726	26,5
	221732	32,5
	221753	53

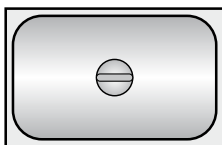

Coperchio in acciaio inox

Lid in stainless steel	Cod.	GN
	221911	1/1
	221912	1/2
	221913	1/3
	221914	1/4
	221916	1/6
	221919	1/9
	221923	2/3
	221924	2/4
	221928	2/8

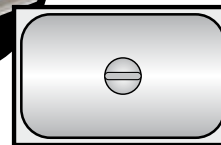

Coperchio in acciaio inox con guarnizione

Lid in stainless steel with trimming	Cod.	GN
	222011	1/1
	222012	1/2
	222013	1/3
	222014	1/4
	222016	1/6
	222023	2/3

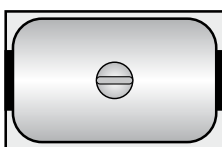

Coperchio in acciaio inox con spacco maniglie

Lid in stainless steel with notch for handles	Cod.	GN
	222111	1/1
	222112	1/2
	222113	1/3
	222116	1/6
	222123	2/3

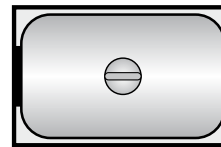

Coperchio in acciaio inox con spacco maniglie e guarnizione

Lid in stainless steel with trimming and notch for handles	Cod.	GN
	222211	1/1
	222212	1/2

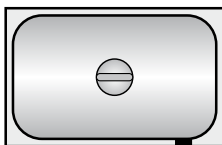

Coperchio in acciaio inox con spacco mestolo

Lid in stainless steel with notch for ladle	Cod.	GN
	222313	1/3
	222314	1/4
	222316	1/6
	222323	2/3

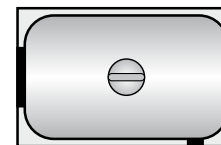

Coperchio in acciaio inox con spacco maniglie e mestolo

Lid in stainless steel with notch for handles and ladle	Cod.	GN
	222411	1/1
	222412	1/2
	222413	1/3
	222423	2/3





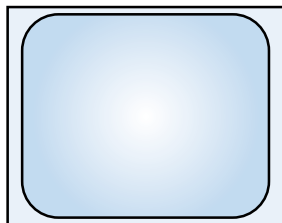

Bacinella GN 2/1 in policarbonato

Gastronorm container 2/1 in polycarbonate	Cod.	L x W cm	H cm
	225020	65 x 53	20

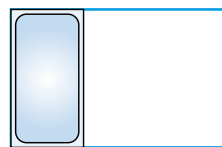

Bacinella GN 1/3 in policarbonato

Gastronorm container 1/3 in polycarbonate	Cod.	L x W cm	H cm
	225406	32,5 x 17,5	6,5
	225410	32,5 x 17,5	10
	225415	32,5 x 17,5	15
	225420	32,5 x 17,5	20



Bacinella GN 1/1 in policarbonato

Gastronorm container 1/1 in polycarbonate	Cod.	L x W cm	H cm
	225106	53 x 32,5	6,5
	225110	53 x 32,5	10
	225115	53 x 32,5	15
	225120	53 x 32,5	20

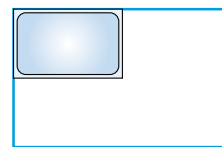

Bacinella GN 1/4 in policarbonato

Gastronorm container 1/4 in polycarbonate	Cod.	L x W cm	H cm
	225506	26,4 x 16,2	6,5
	225510	26,4 x 16,2	10
	225515	26,4 x 16,2	15
	225520	26,4 x 16,2	20

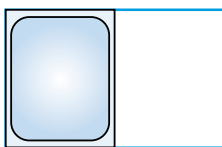

Bacinella GN 1/2 in policarbonato

Gastronorm container 1/2 in polycarbonate	Cod.	L x W cm	H cm
	225306	32,5 x 26,5	6,5
	225310	32,5 x 26,5	10
	225315	32,5 x 26,5	15
	225320	32,5 x 26,5	20



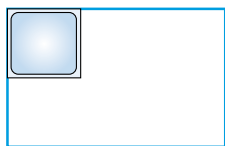

Bacinella GN 1/6 in policarbonato

Gastronorm container 1/6 in polycarbonate	Cod.	L x W cm	H cm
	225606	17,6 x 16,2	6,5
	225610	17,6 x 16,2	10
	225615	17,6 x 16,2	15
	225620	17,6 x 16,2	20

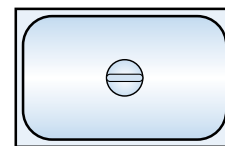

Coperchio in policarbonato

Lid in polycarbonate	Cod.	GN
	226010	2/1
	226011	1/1
	226012	1/2
	226013	1/3
	226014	1/4
	226016	1/6
	226019	1/9



Bacinella GN 1/9 in policarbonato

Gastronorm container 1/9 in polycarbonate	Cod.	L x W cm	H cm
	225706	17,6 x 10,8	6,5
	225710	17,6 x 10,8	10

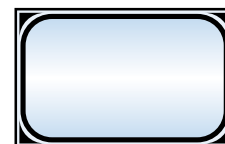

Coperchio a tenuta ermetica in policarbonato

Sealing lid in polycarbonate	Cod.	GN
	226111	1/1
	226112	1/2
	226113	1/3
	226114	1/4
	226116	1/6
	226119	1/9



Falso fondo forato in policarbonato

Gastronorm drainer plate in polycarbonate	Cod.	GN
	227010	2/1
	227011	1/1
	227012	1/2





Bacinella GN 1/1 in polipropilene

Gastronorm container 1/1 in polypropylene	Cod.	L x W cm	H cm
	228106	53 x 32,5	6,5
	228110	53 x 32,5	10
	228115	53 x 32,5	15
	228120	53 x 32,5	20

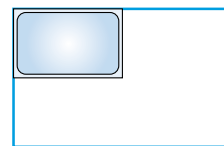

Bacinella GN 1/4 in polipropilene

Gastronorm container 1/4 in polypropylene	Cod.	L x W cm	H cm
	228506	26,4 x 16,2	6,5
	228510	26,4 x 16,2	10
	228515	26,4 x 16,2	15
	228520	26,4 x 16,2	20

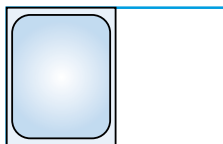

Bacinella GN 1/2 in polipropilene

Gastronorm container 1/2 in polypropylene	Cod.	L x W cm	H cm
	228306	32,5 x 26,5	6,5
	228310	32,5 x 26,5	10
	228315	32,5 x 26,5	15
	228320	32,5 x 26,5	20

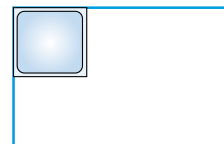

Bacinella GN 1/6 in polipropilene

Gastronorm container 1/6 in polypropylene	Cod.	L x W cm	H cm
	228606	17,6 x 16,2	6,5
	228610	17,6 x 16,2	10
	228615	17,6 x 16,2	15
	228620	17,6 x 16,2	20

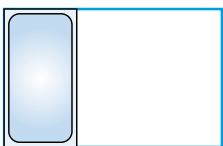

Bacinella GN 1/3 in polipropilene

Gastronorm container 1/3 in polypropylene	Cod.	L x W cm	H cm
	228406	32,5 x 17,5	6,5
	228410	32,5 x 17,5	10
	228415	32,5 x 17,5	15
	228420	32,5 x 17,5	20

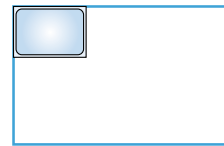

Bacinella GN 1/9 in polipropilene

Gastronorm container 1/9 in polypropylene	Cod.	L x W cm	H cm
	228706	17,6 x 10,8	6,5
	228710	17,6 x 10,8	10

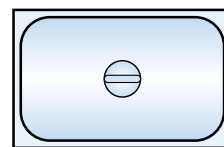

Coperchio in polipropilene

Lid in polypropylene	Cod.	GN
	229011	1/1
	229012	1/2
	229013	1/3
	229014	1/4
	229016	1/6
	229019	1/9



Falso fondo forato in polipropilene

Gastronorm drainer plate in polypropylene	Cod.	GN
	229211	1/1
	229212	1/2
	229213	1/3





Scatola Storplus in policarbonato

Polycarbonate Storplus box	Cod.	L x W cm	H cm	Box
	229409	30,5 x 46	9	6
	229415	30,5 x 46	15,25	6
	229423	30,5 x 46	22,9	6
	229509	45,7 x 66	9	6
	229515	45,7 x 66	15,3	6
	229523	45,7 x 66	22,9	4
	229538	45,7 x 66	38,5	3



Coperchio per scatola Storplus in policarbonato

Lid for polycarbonate Storplus box	Cod.	L x W cm	Box
	229900	30,5 x 46	6
	229901	45,7 x 66	6



Contentore quadrato Storplus in policarbonato

Square Storplus container in polycarbonate	Cod.	L x W cm	H cm	Box
	229609	18,1 x 18,1	9,65	6
	229618	18,1 x 18,1	18,5	6
	229718	22,2 x 22,2	18,6	6
	229723	22,2 x 22,2	22,9	6
	229829	28,3 x 28,3	21	6
	229832	28,3 x 28,3	31,9	6
	229840	28,3 x 28,3	40	6

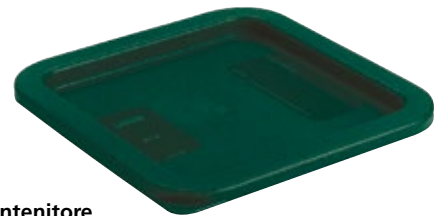

Coperchio per contenitore Storplus quadrato in policarbonato

Lid for square Storplus container in polycarbonate	Cod.	L x W cm	Col.	Box
	229902	18,1 x 18,1		6
	229903	22,2 x 22,2		6
	229904	28,3 x 28,3		6



Terrina rotonda in policarbonato

Round polycarbonate bowl	Cod.	Ø cm	cl	Box
	411801	20	200	12
	411802	25	300	12
	411803	30	500	12
	411804	38	1000	4





PIZZERIA

LINEA TRADIZIONE
TRADITION LINE

93

LINEA DESIGN
DESIGN LINE

94

LINEA GLUTEN FREE
GLUTEN FREE LINE

102

ACCESSORI PIZZERIA
PIZZERIA ACCESSORIES

103

SPATOLE E PALETTE PIZZA
SPATULAS AND PIZZA TURNERS

104



COLLEZIONE PUNTOROSSO

L'UNIONE DI DESIGN, TECNICA ED ESPERIENZA DÀ VITA ALLA NUOVA COLLEZIONE PIZZERIA DI PIAZZA. UNA COMBINAZIONE UNICA DI BELLEZZA ED EFFICIENZA

THE COMBINATION OF DESIGN, TECHNIQUE AND EXPERIENCE CREATES THE NEW PIAZZA'S PIZZERIA COLLECTION. A UNIQUE COMBINATION OF BEAUTY AND EFFICIENCY

La pizzeria di **PIAZZA** si rinnova totalmente, arricchendosi di tanti nuovi prodotti e aggiornando quelli già a catalogo. L'intera collezione è caratterizzata dal pomolo tondo terminale, che, nelle linee Design e Gluten Free, è rigido internamente e morbido all'esterno, avendo così funzione antirumore e antinfortunistica.

The pizzeria in **PIAZZA** is totally renewed, enriching itself with many new products and updating those already in the catalog. The entire collection is characterized by the terminal round knob, which, in the Design and Gluten Free lines, is rigid on the inside and soft on the outside, thus having an anti-noise and accident prevention function.

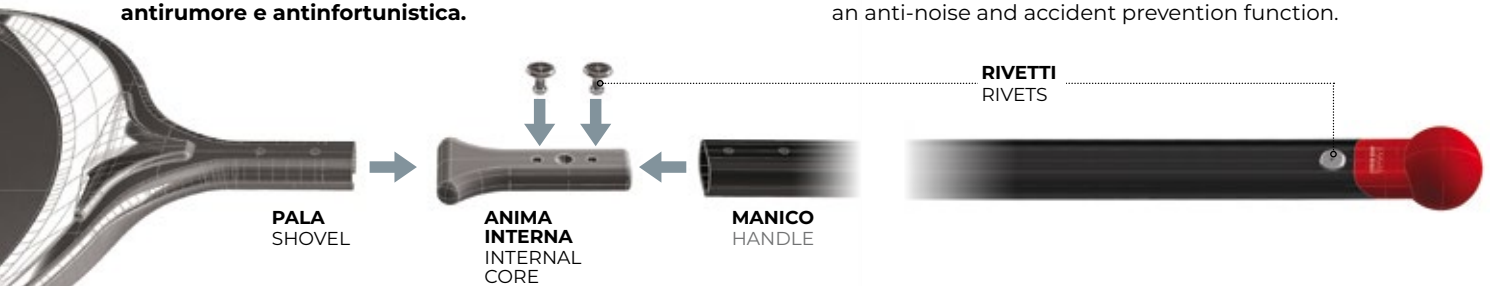

Una collezione progettata, sviluppata e testata curando ogni singolo minimo dettaglio:

- I LATI PALA SMUSSATI RENDONO L'INVITO PIÙ AMPIO E AGEVOLE
- LA SPECIALE NERVATURA POSTERIORE DI RINFORZO GARANTISCE LEGGEREZZA E RESISTENZA AL CALORE
- L'ANIMA INTERNA, INSERITA NELLA PARTE POSTERIORE CAVA DELLA PALA È SOLIDALE CON ESSA E IL MANICO, ENFATIZZA LA ROBUSTEZZA E ASSICURA MASSIMA IGIENE
- IL PARTICOLARE DESIGN DELLE FORATURE ALLEGGERISCE PALE E PALETTINI SENZA INTACCARNE LA RIGIDITÀ
- I 3 RIVETTI DI FISSAGGIO (IN LINEA SULLA PALA E A TRIANGOLO SUI PALETTINI) SONO GARANZIA DI SOLIDITÀ

A collection designed, developed and tested taking care of every single detail:

- THE BEVELED PEEL SIDES MAKE THE INVITATION WIDER AND EASIER
- THE SPECIAL REINFORCEMENT RIB ON THE BACK GUARANTEES LIGHTNESS AND HEAT RESISTANCE
- THE INTERNAL CORE IS INSERTED IN THE BACK HOLLOW OF THE PIZZA PEEL AND IS INTEGRAL PART OF IT AND THE HANDLE, EMPHASIZING ROBUSTNESS AND ENSURING MAXIMUM HYGIENE
- THE PARTICULAR DESIGN OF THE DRILLING LIGHTENS PEELS AND TURNING PEELS WITHOUT AFFECTING THEIR RIGIDITY
- THE 3 FASTENING RIVETS (IN LINE ON THE PEELS AND IN A TRIANGLE SHAPE ON THE TURNING PEELS) ARE A GUARANTEE OF SOLIDITY





Palettino pizza

Pizza turning peel

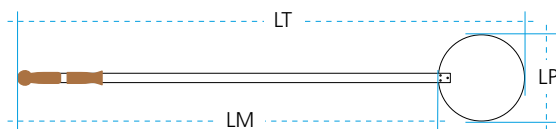

LP Ø18 cm

Cod.	LM	LT
230018	150	168

LP Ø20 cm

Cod.	LM	LT
230020	150	170

LP Ø22 cm

Cod.	LM	LT
230022	150	172

LP Ø24 cm

Cod.	LM	LT
2300024	150	174

Palettino pizza forato

Perforated pizza turning peel

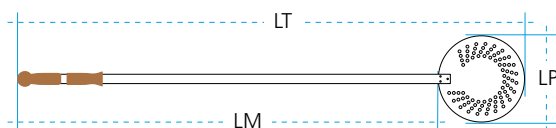

LP Ø18 cm

Cod.	LM	LT
232018	150	168

LP Ø20 cm

Cod.	LM	LT
232020	150	170

LP Ø22 cm

Cod.	LM	LT
232022	150	172

LP Ø24 cm

Cod.	LM	LT
2320024	150	174

Pala pizza rettangolare in alluminio

Rectangular aluminum pizza peel

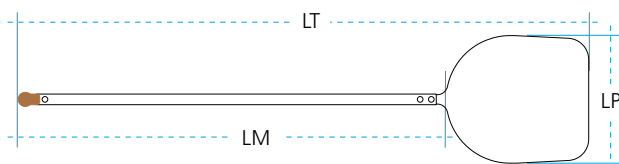

LP 33 cm

Cod.	LM	LT
230433	150	187

LP 36 cm

Cod.	LM	LT
230436	150	190

LP 40 cm

Cod.	LM	LT
230440	150	194

LP 45 cm

Cod.	LM	LT
230445	150	200

LP 50 cm

Cod.	LM	LT
230450	150	205

Pala braci

Charcoal shovel

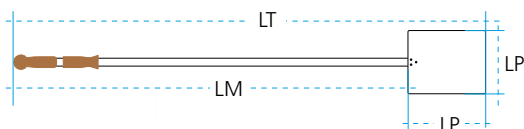

Cod.	LP cm	LM cm	LT cm
230600	21,5x17,5	150	171

Spazzolone forno rettangolare "Cambio rapido" - Setole ottone

Rectangular brass bristle 'Fast change' oven brush



Cod.	LS cm	LM cm	LT cm
231200	16,5x5,5 H 7	150	167

Tirabracci in acciaio

Oven rake

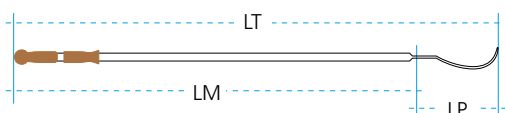

Cod.	LP cm	LM cm	LT cm
230700	19	150	169

Spazzolone forno rettangolare "Cambio rapido" - Setole naturali

Rectangular natural bristle 'Fast change' oven brush



Cod.	LS cm	LM cm	LT cm
231300	16,5x5,5 H 7	150	167

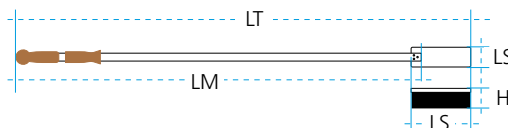

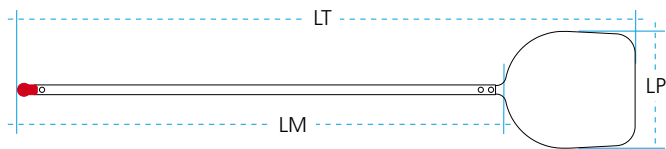

Pala pizza rettangolare in alluminio

Rectangular aluminum pizza peel

LP 30 cm			LP 33 cm			LP 36 cm			LP 40 cm			LP 45 cm			LP 50 cm		
Cod.	LM	LT	Cod.	LM	LT	Cod.	LM	LT	Cod.	LM	LT	Cod.	LM	LT	Cod.	LM	LT
235002	60	94	235012	60	97	235022	60	100	235032	60	104	235042	60	110	235052	60	115
235004	120	154	235014	120	157	235024	120	160	235034	120	164	235044	120	170	235054	120	175
235006	150	184	235016	150	187	235026	150	190	235036	150	194	235046	150	200	235056	150	205
235008	180	212	235018	180	217	235028	180	220	235038	180	224	235048	180	230	235058	180	235
			235019	200	237	235029	200	240									

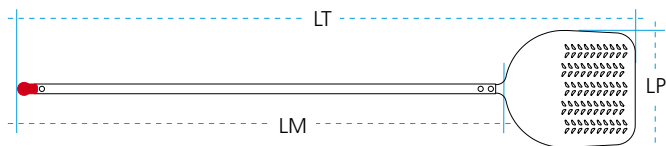

Pala pizza rettangolare forata in alluminio

Rectangular perforated aluminum pizza peel

LP 30 cm			LP 33 cm			LP 36 cm			LP 40 cm			LP 45 cm			LP 50 cm		
Cod.	LM	LT	Cod.	LM	LT	Cod.	LM	LT	Cod.	LM	LT	Cod.	LM	LT	Cod.	LM	LT
235102	60	94	235112	60	97	235122	60	100	235132	60	104	235142	60	110	235152	60	115
235104	120	154	235114	120	157	235124	120	160	235134	120	164	235144	120	170	235154	120	175
235106	150	184	235116	150	187	235126	150	190	235136	150	194	235146	150	200	235156	150	205
235108	180	214	235118	180	217	235128	180	220	235138	180	224	235148	180	230	235158	180	235
			235119	200	237	235129	200	240									



LIBERI DI SCEGLIERE LA PALA PIÙ ADATTA A VOI
FREE TO CHOOSE THE MOST SUITABLE PIZZA PEEL FOR YOU

6 DIFFERENTI MISURE E 2 TIPOLOGIE DI PALA (LISCIA E FORATA)
6 DIFFERENT SIZES AND 2 TYPES OF PIZZA PEELS (PLAIN AND PERFORATED)

6 LUNGHEZZE DI MANICO
6 HANDLE LENGTH

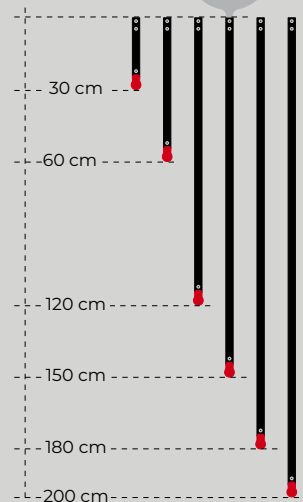

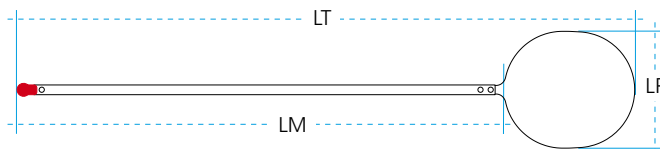

Pala pizza tonda in alluminio

Round aluminum pizza peel

LP 30 cm			LP 33 cm			LP 36 cm			LP 40 cm			LP 45 cm			LP 50 cm		
Cod.	LM	LT	Cod.	LM	LT	Cod.	LM	LT	Cod.	LM	LT	Cod.	LM	LT	Cod.	LM	LT
235202	60	94	235212	60	97	235222	60	100	235232	60	104	235242	60	110	235252	60	115
235204	120	154	235214	120	157	235224	120	160	235234	120	164	235244	120	170	235254	120	175
235206	150	184	235216	150	187	235226	150	190	235236	150	194	235246	150	200	235256	150	205
235208	180	214	235218	180	217	235228	180	220	235238	180	224	235248	180	230	235258	180	235
			235219	200	237	235229	200	240									

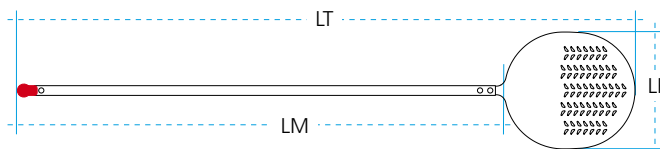

Pala pizza tonda forata in alluminio

Round perforated aluminum pizza peel

LP 30 cm			LP 33 cm			LP 36 cm			LP 40 cm			LP 45 cm			LP 50 cm		
Cod.	LM	LT	Cod.	LM	LT	Cod.	LM	LT	Cod.	LM	LT	Cod.	LM	LT	Cod.	LM	LT
235302	60	94	235312	60	97	235322	60	100	235332	60	104	235342	60	110	235352	60	115
235304	120	154	235314	120	157	235324	120	160	235334	120	164	235344	120	170	235354	120	175
235306	150	184	235316	150	187	235326	150	190	235336	150	194	235346	150	200	235356	150	205
235308	180	214	235318	180	217	235328	180	220	235338	180	224	235348	180	230	235358	180	235
			235319	200	237	235329	200	240									



FINO A 500°C UP TO 932°F

ELASTOMERO MORBIDO ESTERNO ANTIRUMORE E ANTINFORTUNIO
EXTERNAL SOFT ELASTOMER SAFE AND NOISE REDUCTION

RIVETTO RIVET

POLIMERO PLASTICO RIGIDO INTERNO
INNER RIGID PLASTIC POLYMER

LA PALA OFFRE LA MASSIMA SUPERFICIE DISPONIBILE PER INFORNARE SENZA L'INTRALCIO DELLE NERVATURE. LO SMUSSO SU TRE LATI NE ENFATIZZA PRATICITÀ ED EFFICIENZA

THE DESIGN OF THE PIZZA PEEL OFFERS THE MAXIMUM AVAILABLE SURFACE TO PLACE IN THE OVEN WITHOUT OBSTACLES. THE BEVEL ON THE THREE SIDES EMPHASIZES EASE AND EFFICIENCY



NEW

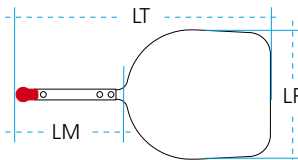

Pala pizza rettangolare in alluminio
Manico corto

Round aluminum pizza peel - Short handle

LP 30 cm			LP 33 cm			LP 36 cm			LP 40 cm			LP 45 cm			LP 50 cm		
Cod.	LM	LT	Cod.	LM	LT	Cod.	LM	LT	Cod.	LM	LT	Cod.	LM	LT	Cod.	LM	LT
235000	30	64	235010	30	67	235020	30	70	235030	30	74	235040	30	80	235050	30	85



NEW

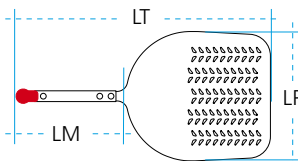

Pala pizza rettangolare forata in alluminio
Manico corto

Rectangular perforated aluminum pizza peel - Short handle

LP 30 cm			LP 33 cm			LP 36 cm			LP 40 cm			LP 45 cm			LP 50 cm		
Cod.	LM	LT	Cod.	LM	LT	Cod.	LM	LT	Cod.	LM	LT	Cod.	LM	LT	Cod.	LM	LT
235100	30	64	235110	30	67	235120	30	70	235130	30	74	235140	30	80	235150	30	85

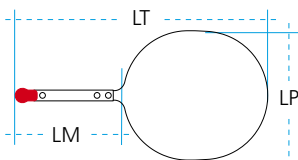

Pala pizza tonda in alluminio
Manico corto

Rectangular aluminum pizza peel - Short handle

LP 30 cm			LP 33 cm			LP 36 cm			LP 40 cm			LP 45 cm			LP 50 cm		
Cod.	LM	LT	Cod.	LM	LT	Cod.	LM	LT	Cod.	LM	LT	Cod.	LM	LT	Cod.	LM	LT
235200	30	64	235210	30	67	235220	30	70	235230	30	74	235240	30	80	235250	30	85



NEW

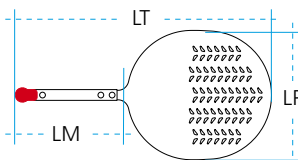

Pala pizza tonda forata in alluminio
Manico corto

Round perforated aluminum pizza peel - Short handle

LP 30 cm			LP 33 cm			LP 36 cm			LP 40 cm			LP 45 cm			LP 50 cm		
Cod.	LM	LT	Cod.	LM	LT	Cod.	LM	LT	Cod.	LM	LT	Cod.	LM	LT	Cod.	LM	LT
235300	30	64	235310	30	67	235320	30	70	235330	30	74	235340	30	80	235350	30	85



1. IMBALLO INDIVIDUALE

Ogni prodotto viene consegnato imballato singolarmente in una scatola in cartone polionda.

2. FACILITÀ DI STOCCAGGIO

Un adesivo esterno con le specifiche del prodotto ne consente l'immediata identificazione all'interno del vostro magazzino.

1. INDIVIDUAL PACKAGING

Each product is delivered individually packed in a corrugated cardboard box.

2. EASE OF STORAGE

An external sticker with product specifications allows immediate identification within your warehouse.



3. MASSIMA PROTEZIONE

All'interno dell'imballo in cartone un sacchetto in plastica o una scatola (per le spazzole), offrono un'ulteriore protezione alle parti più soggette a urti e graffi.

4. INFORMAZIONI CHIARE

Ogni prodotto è accompagnato da un foglio "parlante" che ne riporta le caratteristiche principali: tipologia, materiale, dimensioni, ecc.

3. MAXIMUM PROTECTION

Inside the cardboard packaging, a plastic bag or a box (for the brushes), offer further protection to the most subject parts to bumps and scratches.

4. CLEAR INFORMATION

Each product is accompanied by a "talking" sheet which shows its main characteristics: type, material, dimensions, etc.





Pala pizza "Alla Romana" in alluminio

Aluminum 'Roman style' pizza peel	Cod.	LP cm	LM cm	LT cm
	235400	23x40	30	77
	235402	23x40	60	107
	235404	23x40	120	167

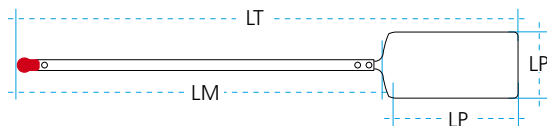

Pala pizza forata "Alla Romana" in alluminio

Perforated aluminum 'Roman style' pizza peel	Cod.	LP cm	LM cm	LT cm
	235500	23x40	30	77
	235502	23x40	60	107
	235504	23x40	120	167

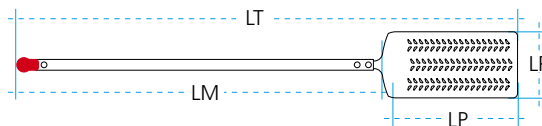

Asse per pizza "Alla Romana" in alluminio

Aluminum 'Roman style' pizza board	Cod.	LP cm
	235802	25x50

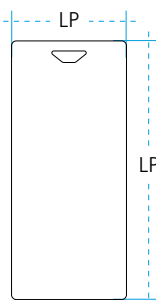

Asse forato per pizza "Alla Romana" in alluminio

Perforated aluminum 'Roman style' pizza board	Cod.	LP cm
	235842	25x50

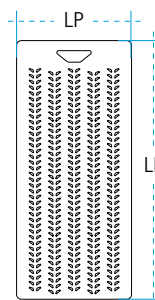

Asse per pizza "A Metro" in alluminio

Aluminum 'Pizza by the Metre' board	Cod.	LP cm
	235812	30x70
	235814	30x90
	235822	40x70
	235824	40x90
	235826	40x110

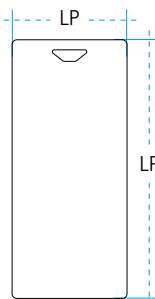

Asse forato per pizza "A Metro" in alluminio

Perforated aluminum 'Pizza by the Metre' board	Cod.	LP cm
	235852	30x70
	235854	30x90
	235862	40x70
	235864	40x90
	235866	40x110

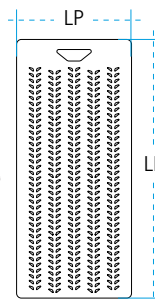

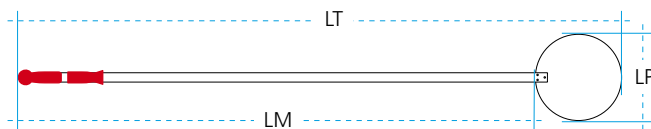

Palettino in inox

Stainless steel pizza turning peel

LP Ø18 cm			LP Ø20 cm			LP Ø22 cm			LP Ø24 cm		
Cod.	LM	LT	Cod.	LM	LT	Cod.	LM	LT	Cod.	LM	LT
236002*	75	93	236012*	75	95	236022*	75	97	236032*	75	99
236004	120	138	236014	120	140	236024	120	142	236034	120	144
236006	150	168	236016	150	170	236026	150	172	236036	150	174
236008	180	198	236018	180	200	236028	180	202	236038	180	204
236009	200	218	236019	200	220	236029	200	222	236039	200	224



* NEI MODELLI CON MANICO DA 75 CM L'IMPUGNATURA HA SOLO LA PARTE FISSA POSTERIORE
IN MODELS WITH A 75 CM HANDLE, THE GRIP ONLY HAS THE REAR FIXED PART

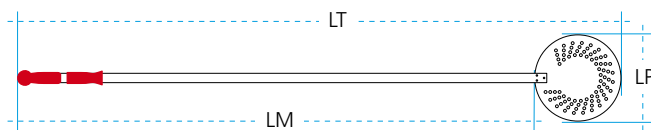
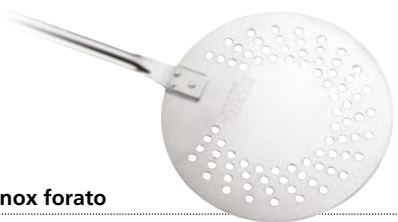

Palettino in inox forato

Perforated stainless steel pizza turning peel

LP Ø18 cm			LP Ø20 cm			LP Ø22 cm			LP Ø24 cm		
Cod.	LM	LT	Cod.	LM	LT	Cod.	LM	LT	Cod.	LM	LT
236102*	75	93	236112*	75	95	236122*	75	97	236132*	75	99
236104	120	138	236114	120	140	236124	120	142	236134	120	144
236106	150	168	236116	150	170	236126	150	172	236136	150	174
236108	180	198	236118	180	200	236128	180	202	236138	180	204
236109	200	218	236119	200	220	236129	200	222	236139	200	224



* NEI MODELLI CON MANICO DA 75 CM L'IMPUGNATURA HA SOLO LA PARTE FISSA POSTERIORE
IN MODELS WITH A 75 CM HANDLE, THE GRIP ONLY HAS THE REAR FIXED PART

PAROLE D'ORDINE: EFFICIENZA E PRATICITÀ
PASSWORDS: EFFICIENCY AND PRACTICALITY

5 LUNGHEZZE DI MANICO, 4 DIFFERENTI MISURE E 2 TIPOLOGIE DI PALETTINO (LISCIO E FORATO)

5 HANDLE LENGTH, 4 DIFFERENT SIZES AND 2 TYPES OF PIZZA TURNING PEELS (PLAIN AND PERFORATED)

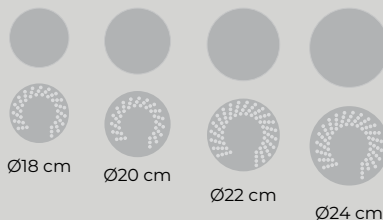

L'ERGONOMICA IMPUGNATURA POSTERIORE È REALIZZATA IN POLIMERO PLASTICO AD ALTA DENSITÀ, CONIUGA LA RESISTENZA AGLI URTI CON L'ISOLAMENTO DELLE MANI DAL CALORE. LA PARTE FISSA POSTERIORE È FISSATA AL MANICO CON UN RIVETTO IN ACCIAIO. LA PARTE MOBILE SCORRE SUL MANICO DAL FERMO ALLA PARTE FISSA, NELLA QUALE, A RIPOSO, SI INCASTRA E SI BLOCCA

THE ERGONOMIC PIZZA TURNING PEEL GRIP IS MADE OF HIGH-DENSITY PLASTIC POLYMER, IT COMBINES IMPACT RESISTANCE WITH PERFECT INSULATION OF THE HANDS FROM HEAT. THE REAR FIXED PART IS FIXED TO THE HANDLE WITH A STEEL RIVET. THE MOBILE PART SLIDES ON THE HANDLE FROM THE STOP TO THE FIXED PART, WHERE, AT REST, IT FITS AND LOCKS

LO SPECIALE DESIGN DEI FORI, PERIMETRALE E A RAGGIERA, EVITA LA FORATURA NELLA PARTE CENTRALE DEL PALETTINO, GARANTENDO UNA PERFETTA RIGIDITÀ

THE SPECIAL DESIGN OF THE HOLES, PERIMETER AND RADIAL, AVOIDS DRILLING IN THE CENTRAL PART OF THE PIZZA TURNING PEEL, GUARANTEEING PERFECT RIGIDITY WITH A REDUCED THICKNESS

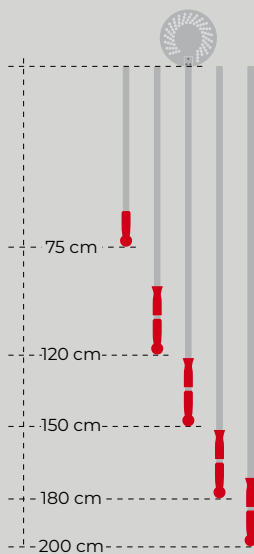



Spazzolone forno orientabile rettangolare - Setole ottone

Rectangular rotatable oven brush with brass bristle

LS 20x6 H 7 cm

LS 27x6,5 H 7 cm

Cod.	LM	LT	Cod.	LM	LT
237004	120	133	237104	120	137
237006	150	163	237106	150	167
237008	180	193	237108	180	197
237009	200	213	237109	200	217

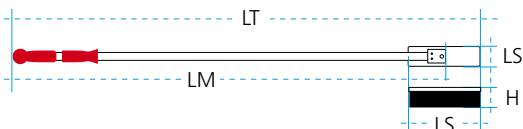

Spazzolone forno orientabile rettangolare - Setole naturali

Rectangular rotatable oven brush with natural bristle

LS 20x6 H 7 cm

Cod.	LM	LT
237014	120	133
237016	150	163
237018	180	193
237019	200	213

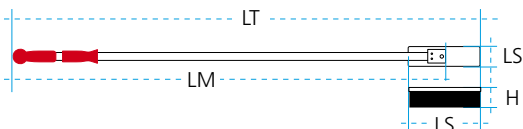

Spazzolone forno orientabile tondo - Setole ottone

Round rotatable oven brush with brass bristle

LS Ø17x14 H 7 cm

Cod.	LM	LT
237504	120	131
237506	150	161
237508	180	191
237509	200	211

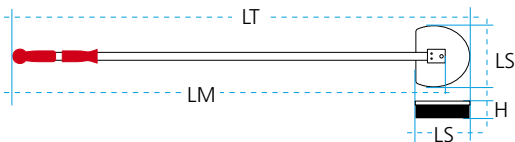

237900



237905

Spazzola forno - Setole ottone

Oven brush - Brass bristle

Cod.	L x W cm	H cm
237900	20 x 6	7
237905	27 x 6,5	7



Spazzola forno - Setole naturali

Oven brush - Natural bristle

Cod.	L x W cm	H cm
237901	20 x 6	7



Spazzola forno tonda Setole ottone

Round oven brush Brass bristle

Cod.	L x W cm	H cm
237920	Ø17 x 14	7



IL SISTEMA DI AGGANCO DELLA SPAZZOLA AL MANICO NE CONSENTE LA ROTAZIONE A 360°
THE HOOKING SYSTEM OF BRUSH AND HANDLE ALLOWS A 360° ROTATION

Spazzolone forno rettangolare "Cambio rapido" - Setole ottone

Rectangular brass bristle 'Fast change' oven brush	Cod.	LS cm	LM cm	LT cm
	237206	16,5x5,5 H 7	150	167



Spazzolone forno rettangolare "Cambio rapido" - Setole naturali

Rectangular natural bristle 'Fast change' oven brush	Cod.	LS cm	LM cm	LT cm
	237216	16,5x5,5 H 7	150	167

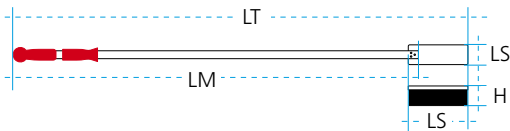

231000



231100



Spazzola forno "Cambio Rapido"

'Fast Change' oven brush	Cod.	Mat.	Box
	231000	ottone/brass	6
	231100	setole natur./natur. bristle	6



Pala braci

Charcoal shovel	Cod.	LP cm	LM cm	LT cm
	239006	21,5x17,5	150	171

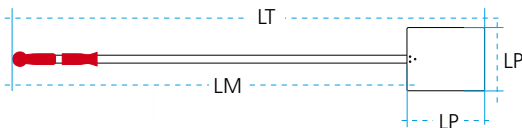

Tirabraci in acciaio

Oven rake	Cod.	LP cm	LM cm	LT cm
	239106	19	150	169

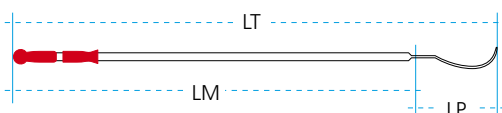

IL FISSAGGIO PALA-MANICO
THE SHOVEL-HANDLE FIXING



LO SMUSSO DELLA PALA
THE SHOVEL'S BEVEL



Pala pizza rettangolare in legno

Rectangular wooden pizza peel

LP 33 cm

LP 36 cm

LP 40 cm

Cod.	LM	LT	Cod.	LM	LT	Cod.	LM	LT
238016	153	187	238026	153	190	238036	153	194

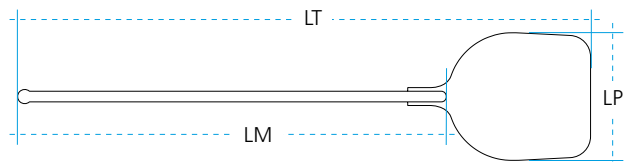

- **REALIZZATA IN LEGNO DI FAGGIO MASSICCIO EVAPORATO, LA CUI PARTICOLARE DUREZZA GARANTISCE ROBUSTEZZA E DURATA NEL TEMPO**
- **RINFORZATA CON BARRE DI ACCIAIO INOX INTERNE.**
- **SPESSORE: 12 MM.**
- **IL TRATTAMENTO CON OLIO ENOLOGICO, CERTIFICATO PER USO ALIMENTARE, RIDUCE L'USURA E AL CONTEMPO FAVORISCE LO SCORRIMENTO DELL'IMPASTO**
- **ANCH'ESSA SMUSSATA SU TRE LATI, PER FAVORIRE, SIA IL TRASCINAMENTO DELL'IMPASTO SULLA PALA CHE IL SOLLEVAMENTO DELLA PIZZA**

- **MADE OF EVAPORATED SOLID BEECH WOOD, WHOSE PARTICULAR HARDNESS GUARANTEES STURDINESS AND DURABILITY**

- **REINFORCED WITH INTERNAL STAINLESS STEEL BARS**

- **THICKNESS: 12 MM.**

- **THE TREATMENT WITH OENOLOGICAL OIL, CERTIFIED FOR FOOD USE, REDUCES WEAR AND AT THE SAME TIME FAVORS THE FLOW OF THE DOUGH**

- **ALSO BEVELED ON THREE SIDES, IN ORDER TO FACILITATE BOTH THE DRAGGING OF THE DOUGH ON THE PIZZA PEEL AND THE LIFTING OF THE PIZZA**

MANICO IN LEGNO

- **OVALE A FACCE PARALLELE**
- **SPESSORE: 15 MM.**

WOODEN HANDLE

- **OVAL WITH PARALLEL FACES**
- **THICKNESS: 15 MM.**

FISSAGGIO DEL MANICO

- **CON VITI A SCOMPARSA A GARANTIRE LA MASSIMA SOLIDITÀ DELL'ASSEMBLAGGIO DI PALA E MANICO**

FIXING OF THE HANDLE

- **WITH CONCEALED SCREWS TO ENSURE MAXIMUM SOLIDITY OF THE ASSEMBLY OF SHOVEL AND PEEL**



NEW

Pala pizza legno betulla

Birch wooden pizza peel	Cod.	L x W cm
	248100	29,5 x 42





Pala pizza rettangolare "Gluten Free" in alluminio

Rectangular aluminum pizza peel for 'Gluten Free' products

LP 33 cm			LP 36 cm		
Cod.	LM	LT	Cod.	LM	LT
235616	150	187	235626	150	190

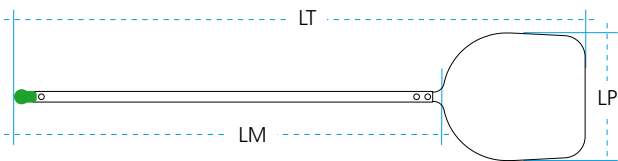

Palettino forato "Gluten Free" in inox

Perforated stainless steel pizza turning peel for 'Gluten Free' products

LP Ø20 cm			LP Ø22 cm		
Cod.	LM	LT	Cod.	LM	LT
236316	150	170	236326	150	172

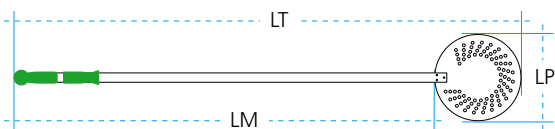

Spazzolone forno "Gluten Free" orientabile rettangolare - Setole ottone

Rectangular oven brush with rotatable brass bristle for 'Gluten Free' products

LS 20x6 H 7 cm		
Cod.	LM	LT
237056	150	163

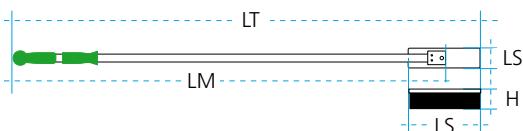

UN'ATTENZIONE SPECIALE PER I PROPRI CLIENTI
SPECIAL ATTENTION FOR YOUR CLIENTS

Negli ultimi anni è cresciuta l'esigenza di poter offrire anche pizze realizzate senza glutine in modo da soddisfare la clientela affetta da celiachia.



Ovviamente bisogna evitare che questi prodotti vengano contaminati dalla farina normalmente presente nelle altre pizze.

STRUMENTI DEDICATI

Oltre all'organizzazione dell'area di lavoro si rende anche necessario l'uso di attrezzi specifici: pale per infornare, palettini per cuocere e spazzoloni per pulire il forno, che siano distinguibili in maniera immediata da quelli normalmente utilizzati.

RICONOSCIBILI A COLPO D'OCCHIO

Ecco quindi la collezione Gluten Free di PIAZZA: strumenti con le stesse caratteristiche d'eccellenza di quelli della normale Linea Pizzeria ma contraddistinti dal pomolo terminale e dalle impugnature di colore verde anziché rosso.

In recent years, the need has grown to be able to offer pizzas made without gluten in order to satisfy customers with celiac disease.

Obviously it is necessary to avoid that these products are contaminated by the flour normally present in other pizzas.

DEDICATED TOOLS

In addition to the organization of the work area, it is also necessary to use specific tools: pizza peel for ovening, pizza turning peel for cooking and brushes for cleaning the oven, which are immediately distinguishable from those normally used.

RECOGNIZABLE AT A GLANCE

Here is the PIAZZA Gluten Free collection: tools with the same excellent characteristics as those of the normal Pizzeria Line but characterized by the terminal knob and green rather than red handles.





Spazzola e raschietto 2 usi con setole in inox

2 in 1 brush and scraper with st. steel bristle

Cod.	L cm
231250	23



NEW

Appendipala inox da parete - 1 posto

St. steel wall mounted 1 place peel rack

Cod.	L x W cm	H cm
239501	19 x 4	6



Alare

Firedog

Cod.	H cm
231400	41



APPENDIPALA 1 POSTO
1 PLACE PEEL RACK



APPENDIPALE 3 POSTI
3 PLACES PEEL RACK



Contenitore palline per pizza in plastica

Plastic box for dough stackable

Cod.	L x W cm	H cm
245207	60 x 40	7
245210	60 x 40	10

NEW



Contenitore palline per pizza in plastica con coperchio

Plastic box for dough stackable with lid

Cod.	L x W cm	H cm
245211	60 x 40	10



Coperchio contenitore palline per pizza in plastica

Plastic cover

Cod.	L x W cm
245400	60 x 40

NEW



Appendipale inox da parete - 3 posti

St. steel wall mounted 3 places peel rack

Cod.	L x W cm	H cm
239503	30 x 5	5





Spatola angolare Design by Michele Capuani

Angular spatula	Cod.	L cm
	240010	10
	240022	22
	240026	26
	240030	30
	240036	36



Spatola angolare appuntita Design by Michele Capuani

Tapered point angular spatula	Cod.	L cm
	240011	11



Spatola diritta Design by Michele Capuani

Spatula	Cod.	L cm
	240112	12
	240115	15
	240120	20
	240122	22
	240126	26
	240130	30
	240136	36



Spatola triangolare Design by Michele Capuani

Triangle spatula	Cod.	W x L cm
	240208	8 x 12
	240210	10 x 12
	240212	12 x 12



Spatola forata Design by Michele Capuani

Perforated spatula	Cod.	W x L cm
	240300	7,5 x 16



Spatola per hamburger Design by Michele Capuani

Hamburger turner	Cod.	W x L cm
	240400	7 x 24
	240401	14 x 19



Spatola per pizza Design by Michele Capuani

Pizza turner	Cod.	W x L cm
	240501	9 x 15,5



Tagliapasta Design by Michele Capuani

Dough cutter	Cod.	W x L cm
	240600	16 x 12





Raschia Design by Michele Capuani
 Scraper

Cod.	W x L cm
240601	12 x 9,5
240640	15 x 7,5



Raschia Design by Michele Capuani
 Scraper

Cod.	W x L cm
240700	15 x 6



Tronchetto tagliapizza Design by Michele Capuani
 Pizza cutter

Cod.	W x L cm
240800	14 x 6



Rotella tagliapizza Design by Michele Capuani
 Pizza wheel cutter

Cod.	Ø cm
241106	5,5
241110	10



Paletta pizza ovale forata Design by Michele Capuani
 Oval perforated pizza turner

Cod.	W x L cm
240900	18 x 22



Paletta pizza ovale Design by Michele Capuani
 Oval pizza turner

Cod.	W x L cm
240901	18 x 22



Paletta pizza triangolare forata Design by Michele Capuani
 Triangle perforated pizza turner

Cod.	W x L cm
241000	12 x 16



Paletta pizza triangolare Design by Michele Capuani
 Triangle pizza turner

Cod.	W x L cm
241001	12 x 16



PASTICCERIA

PÂTISSERIE

MOLLE E PINZE PER DOLCI PASTRY TONGS AND SCISSOR SERVERS	108
SOFLEX - STAMPI IN SILICONE SOFLEX - SILICONE MOULDS	110
SACCAPOCHE E BOCCHETTE PASTRY BAGS AND DECORATING NOZZLES	112
SPATOLE SPATULAS	116
RULLI E PENNELLI ROLLING PINS AND PASTRY BRUSHES	119
TAGLIAPASTA E TAGLIABISCOTTI PASTRY AND BISCUIT CUTTERS	120
STAMPI E FORME MOULDS	125
ACCESSORI PASTICCERIA PÂTISSERIE ACCESSORIES	134



Molla per dolci

Pastry tong	Cod.	L cm	Box
	010600	18	12



Mollunga per toast e dolci

Design by Michele Capuani

Buffet toast tong 'Mollunga'	Cod.	L cm	Box
	011000	30	12



Molla per dolci

Pastry tong	Cod.	L cm	Box
	011900	16,5	12



Molla per toast e dolci

Ice cube tong	Cod.	L cm	Box
	012500	21	12



CONTROLLATE UNA AD UNA
CHECKED ONE BY ONE

Tutte le nostre molle e pinze in acciaio inox sono interamente prodotte nei nostri stabilimenti. Grazie agli investimenti tecnologici la linea di produzione robotizzata ha ora una potenzialità produttiva di 6.000.000 di molle l'anno. Per diventare una molla PIAZZA però tutte, nessuna esclusa, devono passare l'ultimo esame, il più difficile, uno scrupoloso e certosino controllo manuale della loro precisione di chiusura e della loro straordinaria capacità di conservare l'elasticità nel tempo, una caratteristica questa, dovuta ad un passaggio produttivo che solo noi conosciamo e che ancora gelosamente custodiamo. Sarà per questo che qualcuno ci ha definito "King of Tongs"...

All our stainless steel tongs and scissor servers are produced entirely in our Italian factories. Thanks to investments in technology, our automated line now has production capacity of 6,000,000 tongs a year. However, to become a PIAZZA tong, all of them, without exception, must pass a final exam, the most difficult one: painstaking manual control of their closing accuracy and extraordinary ability to retain their spring over time. This last is a characteristic made possible thanks to a special step in the production process that is known to us alone and jealously guarded. Perhaps this is why we have been called the "King of Tongs"...





Pinza per dolci forgiata

Pastry scissor server

Cod.	L cm
020000	16,5



Pinza per torta forgiata

Pie scissor server

Cod.	L cm
020400	25



Pinza per dolci forgiata

Pastry scissor server

Cod.	L cm
020100	20



Pinza per dolci "Mignon" forgiata

Midget scissor server
'Mignon'

Cod.	L cm
020700	15



Pinza per dolci forgiata

Pastry scissor server

Cod.	L cm
020200	20
0202001	20



Cod. 0202001



Pinza per dolci "Mignon" forgiata

Midget scissor server
'Mignon'

Cod.	L cm
020800	15



Pinza per dolci forgiata

Pastry scissor server

Cod.	L cm
020300	21
0203001	21



Cod. 0203001



Pinza per forno

Hot plate holder

Cod.	L cm
021100	18,5





Forme per semisfera

Soflex Halph-Spheres Cod. Ø cm H cm
260000 7 4

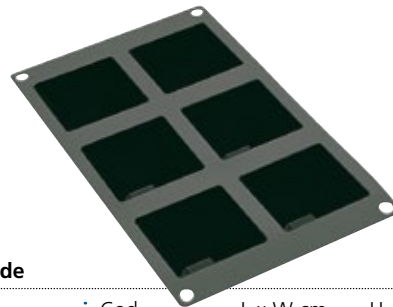

Forme per piramide

Soflex Pyramid Cod. L x W cm H cm
260400 7 x 7 4



Forme per muffin

Soflex Muffin Cod. Ø cm H cm
260105 7 4



Forme per tarteletta

Soflex Tartlet Cod. Ø cm H cm
260600 7,5 2



Forme per cilindro

Soflex Cylinder Cod. Ø cm H cm
260110 6 3,5



Forme per briochette

Soflex Briochette Cod. Ø cm H cm
260800 8,2 3,7



Forme per cilindro

Soflex Cylinder Cod. Ø cm H cm
260115 4 2



Forme per bordelais

Soflex Bordelais Cod. Ø cm H cm
260905 5,6 5

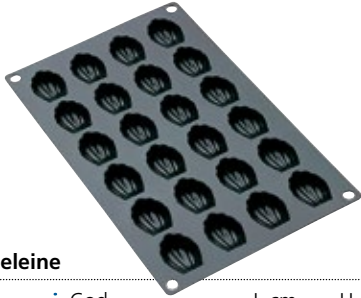

Forme per mini-madeleine

Soflex Mini-madeleine	Cod.	L cm	H cm
	261200	4,2	1,2



Tortiera

Soflex Cake	Cod.	Ø cm	H cm
	261300	18	3
	261306	22	4
	261310	26	4
	261330	15,2	5,1



Forme per madeleine

Soflex Madeleine	Cod.	L cm	H cm
	261205	8	4,8



Tortiera festonata

Soflex Festooned Cakestand	Cod.	Ø cm	H cm
	261405	24	3
	261410	26	3
	261415	28	3



Forma per plum-cake

Soflex Plum-cake	Cod.	L x W cm	H cm
	261500	26 x 10	7,5

Soflex
by **PIAZZA**





Saccapoche nylon "Superflex"



'Superflex' nylon pastry bags	Cod.	L cm	Box
	2751252	25	6
	2751282	28	6
	2751342	34	6
	2751402	40	6
	2751462	46	6
	2751502	50	6
	2751552	55	6
	2751602	60	6



Saccapoche nylon "Professionale"



'Professional' nylon pastry bags	Cod.	L cm	Box
	2753252	25	6
	2753282	28	6
	2753342	34	6
	2753402	40	6
	2753462	46	6
	2753502	50	6
	2753552	55	6
	2753602	60	6



Saccapoche monouso in polietilene a rotolo



Disposable pastry bags - one roll	Cod.	L cm	T μ
	275501	50	70
	275503	30	70
	275505	40	70



Set 3 saccapoche "Superflex"

3 different pastry bags "Superflex"	Cod.	L cm	Box
	275700	34 - 46 - 50	6



Cono portasacchetto in polipropilene

Polypropylene support for pastry bags	Cod.
	276000

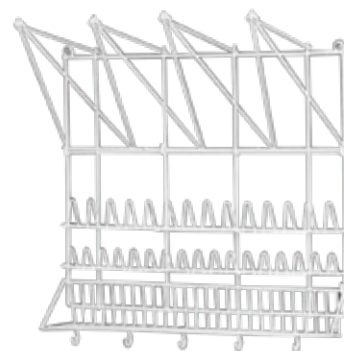

Porta saccapoche da muro verniciato

Wall rack for pastry bags - white coating	Cod.
	276200





Bocchetta per decorazione acciaio inox foro a stella



Star decorating nozzle - stainless steel

Cod.	Ø mm
2763022	2
2763032	3
2763042	4
2763052	5
2763062	6
2763072	7
2763082	8
2763092	9
2763102	10
2763112	11
2763122	12
2763132	13
2763142	14
2763152	15
2763162	16
2763172	17
2763182	18

Bocchetta per decorazione acciaio inox foro tondo



Plain decorating nozzle - stainless steel

Cod.	Ø mm
2764022	2
2764032	3
2764042	4
2764052	5
2764062	6
2764072	7
2764082	8
2764092	9
2764102	10
2764112	11
2764122	12
2764132	13
2764142	14
2764152	15
2764162	16
2764172	17
2764182	18
2764202	20
2764222	22
2764242	24



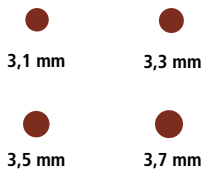

Set per alta decorazione: 4 bocchette foro tondo, portabocchette, saccapoche

Decoration set: 4 nozzles plain, nozzles ring, pastry bag
 Cod. **276501** L cm 34

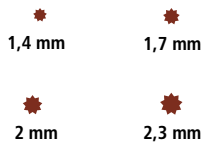

Set per alta decorazione: 4 bocchette foro stella, portabocchette, saccapoche

Decoration set: 4 nozzles star, nozzles ring, pastry bag
 Cod. **276502** L cm 34

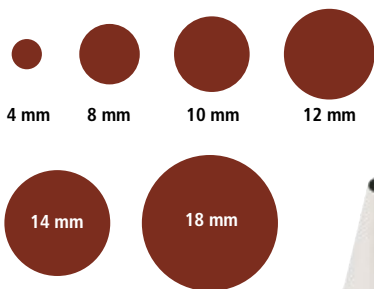

Set 6 bocchette inox foro tondo

Set of 6 stainless steel plain nozzles
 Cod. **276601**

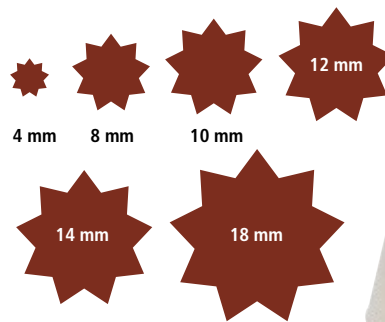

Set 6 bocchette inox foro stella

Set of 6 stainless steel star nozzles
 Cod. **276602**

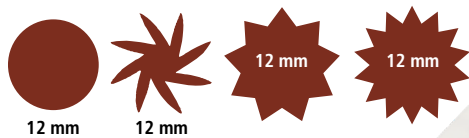

Set decorazione: 4 bocchette inox e saccapoche

Decoration set: 4 stainless steel nozzles + pastry bag
 Cod. **276603** L cm 34

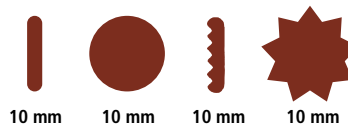

Set decorazione: 4 bocchette inox e saccapoche

Decoration set: 4 stainless steel nozzles + pastry bag
 Cod. **276604** L cm 34

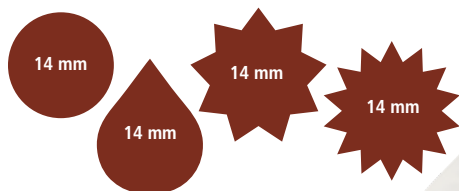

Set decorazione: 4 bocchette inox e saccapoche

Decoration set: 4 stainless steel nozzles + pastry bag
 Cod. **276605** L cm 34



Porzionatore in plastica per torta 12/18 porzioni

Plastic cake marker, 12-18 slices
 Cod. **277102** Box 6





Set 5 bocchette inox

Set of 5 stainless steel decorating nozzles

Cod. 276703



Set 5 bocchette inox

Set of 5 stainless steel decorating nozzles

Cod. 276704



Cannoli cilindrici in latta

Tin cream cylindrical cornet moulds

Cod. 276801

L cm 13
Ø cm 2
Box 6

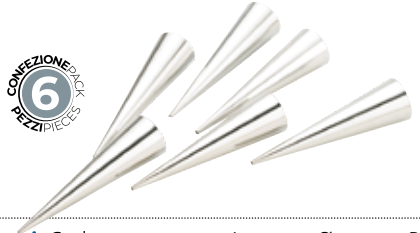

Cannoli conici in latta

Tin cream cylindrical cornet moulds

Cod. 276802

L cm 12
Ø cm 3
Box 6



Cassetta 12 bocchette polipropilene

Polypropylene 12 pcs - nozzles box

Cod. 276901



Cassetta 12 bocchette polipropilene

Polypropylene 12 pcs - nozzles box

Cod. 276902



Scatola bocchette inox assortite per decorazione

Set of different stainless steel decorating tubes

Cod. 277026
277052

Pcs. 26
52



Bocchetta inox ad imbuto

Filling tubes in st. steel

Cod. 277100



Bruschino per pulire le bocchette

Pastry tubes brush

Cod. 277101

Box 6



Bocchetta Saint-Honoré in acciaio inox

Saint-Honoré decorating nozzle stainless steel

Cod. 277200



Tagliapasta in Exoglas festonato

Pastry cutter serrated	Cod.	L cm	Box
	280005	3,5	6
	280006	4	6
	280007	5	6
	280008	6	6
	280009	7	6
	280010	8	6



Tagliapasta in Exoglas liscio

Pastry cutter plain	Cod.	L cm	Box
	280020	3,5	6
	280021	4	6
	280022	5	6
	280023	6	6
	280024	7	6
	280025	8	6
	280026	9	6

SPATOLE IN PLASTICA: IDEALI IN OGNI PREPARAZIONE
 PLASTIC SPATULAS: IDEAL IN ALL KINDS OF PREPARATION

Le spatole professionali in plastica di PIAZZA vantano caratteristiche che le rendono ideali per tutte le situazioni di preparazione. Robuste e leggere al tempo stesso, l'ottima flessibilità dell'applicazione consente loro di adattarsi perfettamente ad ogni tipo di angolo.

- MANICO IN MATERIALE COMPOSITO (POLIAMMIDE E FIBERGLASS) RESISTENTE FINO A +220°C
- APPLICAZIONI RESISTENTI ALLE ALTE TEMPERATURE
 - SILICONE FINO A +300°C
 - COPOLIESTERE TERMOPLASTICO FINO A +160°C
- IDEALI PER L'USO SU FONDI ANTIADERENTI
- STERILIZZABILI E LAVABILI IN LAVASTOVIGLIE
- PROGETTATE E SVILUPPATE DA PIAZZA
- TOTALMENTE PRODOTTE IN ITALIA

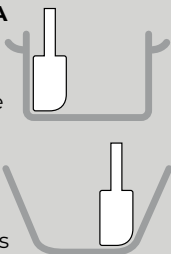

PIAZZA'S professional, plastic spatulas have special features that make them ideal for all kinds of food preparation. Sturdy and light at the same time and the great flexibility of the blade enables them to adapt perfectly to every type of angle.

- HANDLE IN COMPOSITE MATERIAL (POLYAMIDE AND GLASS FIBRE), RESISTANT UP TO +220°C / 428°F
- BLADES RESISTANT TO HIGH TEMPERATURES
 - SILICONE UP TO +300°C / 572°F
 - THERMOPLASTIC COPOLYESTER UP TO +160°C / 320°F
- PERFECT FOR USE ON NON-STICK SURFACES
- CAN BE STERILISED AND ARE DISHWASHER FRIENDLY
- DESIGNED AND DEVELOPED BY PIAZZA
- ENTIRELY MANUFACTURED IN ITALY



Spatola professionale "Vasetto" in plastica



FINO A
UP TO
+160°C

Professional plastic spatula for jar	Cod.	L cm
	285000	25



Spatola professionale in plastica

Professional plastic spatula	Cod.	L cm
	285001	25
	285002	35
	285003	45



Spatola professionale applicazione in silicone



FINO A
UP TO
+300°C

Professional spatula with silicone blade	Cod.	L cm
	285012	35





Spatola taglia impasti in plastica

Cutter for pies and fat	Cod.	L cm	Box
	285112	23	12



Spatolina in plastica

Scraper in polystyrene - trapezoidal shape	Cod.	L x W cm	Box
	285129	21,5 x 13	10



Spatola in exoglas

Spatula made of exoglas	Cod.	L cm	Box
	285113	25	6
	285114	30	6
	285115	35	6
	285116	40	6
	285117	45	6
	285118	50	6



Spatolina in plastica

Scraper in polystyrene - semicircle	Cod.	L x W cm	Box
	285130	19,5 x 15	10



Set 7 spatole polipropilene

Polypropylene spatulas - 7 pcs	Cod.	Box
	285123	10



Paletta da dolce

Stainless steel cake peel	Cod.
	285138

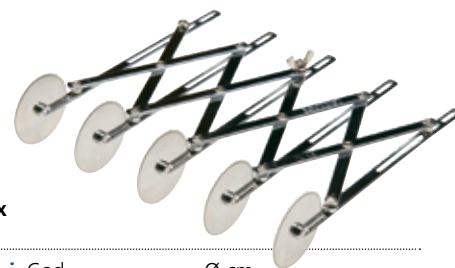

Tagliapasta multiplo inox 5 rotelle lisce

St. steel dough divider 5 plain wheels	Cod.	Ø cm
	285216	5,5



Spatolina in plastica

Scraper in polypropylene	Cod.	L x W cm	Box
	285124	14,5 x 9,5	10
	285125	12 x 8,5	10
	285126	14,5 x 9,5	10
	285127	12 x 9	10
	285128	15 x 11	10

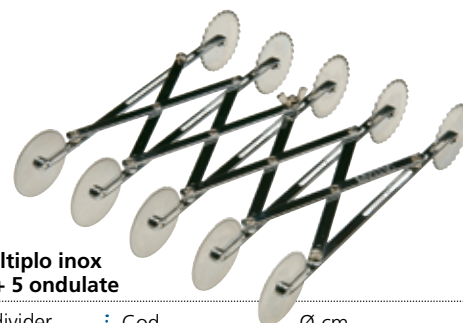

Tagliapasta multiplo inox 5 rotelle lisce + 5 ondulate

St. steel dough divider 5 plain wheels + 5 serrated	Cod.	Ø cm
	285217	5,5





Spatola angolare Design by Michele Capuani

Angular spatula	Cod.	L cm
	240010	10
	240022	22
	240026	26
	240030	30
	240036	36



Spatola angolare appuntita Design by Michele Capuani

Tapered point angular spatula	Cod.	L cm
	240011	11



Spatola diritta Design by Michele Capuani

Spatula	Cod.	L cm
	240112	12
	240115	15
	240120	20
	240122	22
	240126	26
	240130	30
	240136	36



Spatola triangolare Design by Michele Capuani

Triangle spatula	Cod.	W x L cm
	240208	8 x 12
	240210	10 x 12
	240212	12 x 12



Tagliapasta Design by Michele Capuani

Dough cutter	Cod.	W x L cm
	240600	16 x 12



Raschia Design by Michele Capuani

Scraper	Cod.	W x L cm
	240601	12 x 9,5
	240640	15 x 7,5



Raschia Design by Michele Capuani

Scraper	Cod.	W x L cm
	240700	15 x 6



Rotella liscia Design by Michele Capuani

Wheel cutter - plain	Cod.	Ø cm
	241106	5,5
	241110	10



Rotella ondulata inox, manico plastica

Wheel fluted cutter - st. steel, plastic handle	Cod.	Ø cm
	285219	5,5



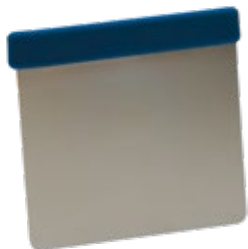

Raschietto inox flessibile

Flexible stainless steel desk cleaner

Cod.	L cm	Box
285131	12	6

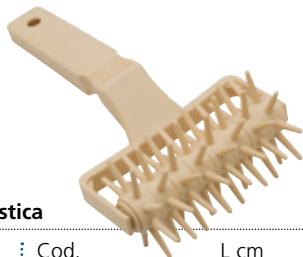

Rullo bucasfoglia in plastica

Plastic roller with spikes

Cod.	L cm
285301	6,5
285302	12



Rullo tagliapasta in plastica

Plastic roller cutter

Cod.	L cm
285303	6,5



Rullo losanghe in plastica

Plastic lozenge cutter

Cod.	L cm
285304	6,5
285305	12



Rullo girevole in legno

Wooden rolling pin

Cod.	L cm	Ø cm
285310	65	10



Rullo girevole in polietilene

PE rolling pin

Cod.	L cm	Ø cm
285311	50	7



Taglia croissant

Croissant roller cutter

Cod.	L x W cm
285312	18 x 14



Pennello

Baker brush

Cod.	L cm	Box
285401	4	12

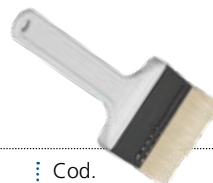

Pennello

Baker brush

Cod.	L cm	Box
285402	6	12

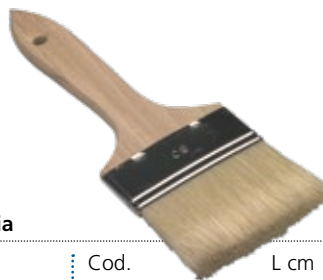

Pennello pasticceria

Pastry brush

Cod.	L cm	Box
285405	2	12
285406	2,5	12
285409	4	12
285410	5	12
285411	6	12
285412	8	12
285413	10	12



Pennello pasticceria

Pastry brush

Cod.	L cm	Box
285415	4	12



Tagliapasta a cuore

Cake cutter - heart

Cod. **285520** Ø cm 6

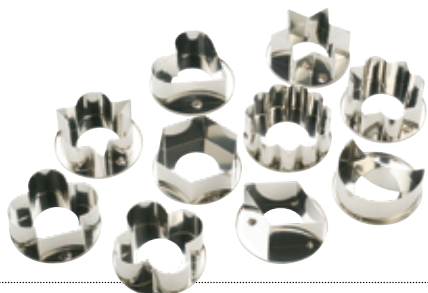

Set 10 tagliapasta assortiti in latta

Tin pastry cutters - different shapes 10 pcs

Cod. **285521** Ø cm 6



Scatola 14 tagliapasta festonati in latta

Different tin pastry cutters - serrated

Cod. **285522** Ø cm 1,5 → 10



Scatola 14 tagliapasta lisci in latta

Different tin pastry cutters - plain

Cod. **285523** Ø cm 2 → 11



Set 6 tagliabiscotti a goccia in latta

Set of 6 biscuit cutters in tin - drop

Cod. **285524**



Scatola 12 tagliapasta in latta, grandi

Box of 12 pastry cutters in tin - big

Cod. **285525**



Scatola 12 tagliapasta in latta, piccoli

Box of 12 pastry cutters in tin - little

Cod. **285526** L cm 1,5



Scatola 6 tagliabiscotti a cuore in latta

Box of 6 biscuit cutters in tin - heart

Cod. **285527**



Scatola 6 tagliabiscotti a rosa in latta

Box of 6 biscuit cutters in tin - rose

Cod. **285528**



Scatola 6 tagliabiscotti a mezza luna in latta

Box of 6 biscuit cutters in tin - half moon

Cod. **285530**



Tagliabiscotti a pesce piccolo in latta

Fish shaped biscuit cutter in tin - little

Cod. 285531 L x W cm 7,5 x 5



Set 6 tagliabiscotti a trifoglio in latta

Set of 6 biscuit cutters in tin - shamrock

Cod. 285535



Set 12 tagliabiscotti ad anello frastagliato in latta

Set of 12 indented ring biscuit cutters in tin

Cod. 285532



Set 6 tagliabiscotti a stella in latta

Set of 6 biscuit cutters in tin - star

Cod. 285536



Set 6 tagliabiscotti a quadrato lisci in latta

Set of 6 biscuit cutters in tin - plain square

Cod. 285533



Set 5 tagliabiscotti a quadrato festonati in latta

Set of 5 biscuit cutters in tin - festooned square

Cod. 285537



Set 6 tagliabiscotti ad esagono in latta

Set of 6 biscuit cutters in tin - hexagon

Cod. 285534



Set 6 tagliabiscotti ovali in latta

Set of 6 biscuit cutters in tin - oval

Cod. 285538



Tagliabiscotti forma gallo piccolo in latta

Cockerel shaped biscuit cutter in tin - little

Cod. 285542 L x W cm 8 x 6



Scatola tagliapasta lettere (26 pezzi) in latta

Pastry cutters in tin: alphabet (26 pcs.) Cod. **285554**



Scatola tagliapasta numeri (9 pezzi) in latta

Pastry cutters in tin: numbers (9 pcs.) Cod. **285555**



Scatola tagliapasta animali (10 pezzi) in latta

Pastry cutters in tin: animals (10 pcs.) Cod. **285556**



Scatola tagliapasta mezzi di trasporto (5 pezzi) in latta

Pastry cutters in tin: vehicles (5 pcs.) Cod. **285557**



Scatola tagliapasta forme geometriche (42 pezzi) in latta

Pastry cutters in tin: shapes (42 pcs.) Cod. **285558**



Tagliapasta cerchio liscio in latta con manico

Round pastry cutter in tin with handle, plain Cod. **285563** Ø cm 6 H cm 3



Tagliapasta cerchio festonato in latta con manico

Round pastry cutter in tin with handle, serrated Cod. **285564** Ø cm 6 H cm 4



Tagliapasta cerchio liscio in latta

Round pastry cutter in tin with handle, plain Cod. **285565** Ø cm 10 H cm 3



Tagliapasta inox dentellata

Stainless steel pastry cutter, serrated Cod. **285569** Ø cm 12



Tagliapasta inox liscia

Stainless steel pastry cutter, plain Cod. **285570** Ø cm 12



Set 12 tagliapasta inox cerchio dentellato

Pastry cutter ring, serrated (set of 12 pcs.) Cod. 285571 Ø cm 3 → 14



Set 9 tagliapasta inox cuore dentellato

Pastry cutter hearth, serrated (set of 9 pcs.) Cod. 285572 Ø cm 6 → 14



Set 12 tagliapasta inox cerchio liscio

Pastry cutter ring, plain (set of 12 pcs.) Cod. 285573 Ø cm 3 → 14



Set 9 tagliapasta inox stella liscia

Pastry cutter star, plain (set of 9 pcs.) Cod. 285574 Ø cm 3,7 → 15



Set 9 tagliapasta praline inox

Stainless steel praline cutters (set of 9 pcs.) Cod. 285575 L x W cm 3,5 x 2 - 2,5 x 2,5 - 4 x 2,6
3 x 1,5 - 3,5 x 3 - 4 x 2
2 x 2,3 - 3,5 x 1,8 - Ø2,6

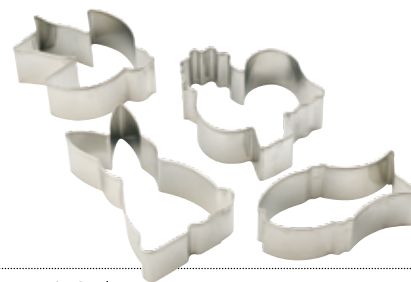

Set 4 tagliapasta assortiti in latta

Set of 4 pcs. pastry cutter in tin Cod. 285598 L x W cm 8 x 6 H cm 3 Box 6

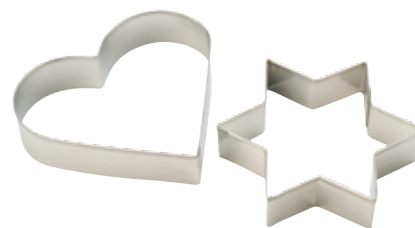

Set 2 tagliapasta assortiti in latta

Set of 2 pcs. pastry cutter in tin Cod. 285599 L x W cm 12 x 12 H cm 3 Box 6



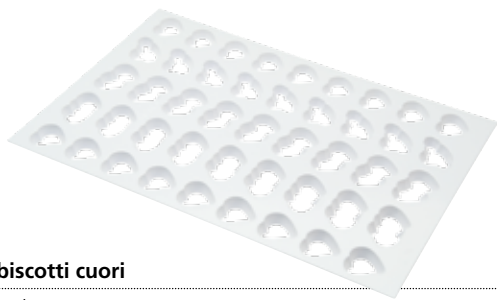

Griglia tagliabiscotti cuori

Sheet of cutters: hearts

Cod.	L x W cm	H cm
285600	60 x 40	2



Griglia tagliabiscotti mezzi di trasporto

Sheet of cutters: vehicles

Cod.	L x W cm	H cm
285601	60 x 40	2

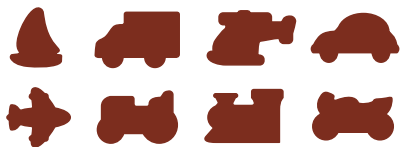

Griglia tagliabiscotti strumenti musicali

Sheet of cutters: musical instruments

Cod.	L x W cm	H cm
285602	60 x 40	2



Contenitori per pasticcini

Baking cases

Cod.	Ø cm	H cm
290001	1,8	1,4
290002	2,4	1,6
290003	3,5	2
290004	4	2,1
290005	4	2,5
290006	5	2,5
290007	5,5	2,5
290008	6	2,5
290009	6,5	2,2
290010	7	2
290011	7,5	2,1
290012	8	2,5



Sottotorta rotondi

Round doyleys

Cod.	Total Ø cm	Ø cm
290101	9	5
290102	12	8
290103	14	8
290105	16	10
290106	19	10
290108	22	14
290110	24	17
290111	26	18
290112	28	19
290113	30	21
290114	32	21
290115	34	24
290116	36	25
290117	38	26
290119	42	32



Sottotorta quadrati e rettangolari

Square and rectangular doyleys

Cod.	L x W cm
290202	18 x 30
290204	20 x 40
290205	30 x 40
290206	36 x 46





Busta per cuoco in carta

Low forage hat	Cod.	H cm	Box
	290300	8,5	30



Cappello da cuoco standard in carta

Pleated hat - standard	Cod.	H cm	Box
	290400	21,6	10



Sessola in plastica

Flour scoop in polypropylene	Cod.	L cm	Box
	290619	19	6
	290625	25	6
	290631	31	6
	290635	35	6
	290640	40	6



Misurino in plastica

Measuring cup	Cod.	lt	Box
	290702	0,25	6
	290705	0,5	6
	290710	1	6
	290720	2	
	290730	3	
	290750	5	

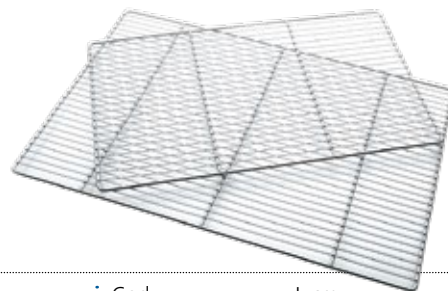

Griglia inox

Flat rack	Cod.	L cm
	291053	53 x 32,5 GN 1/1
	291060	60 x 40
	291065	65 x 53 GN 2/1

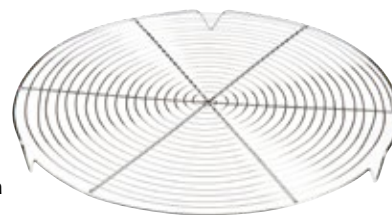

Griglia tonda cromata con piedini

Cake cooling tray with feet	Cod.	Ø cm
	291066	36

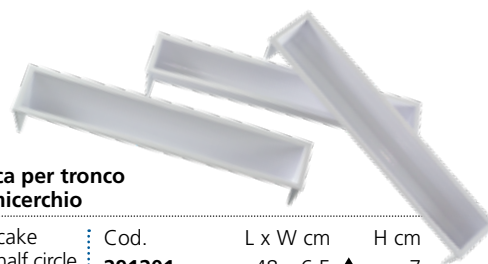

Stampo in plastica per tronco a triangolo e semicerchio

Plastic long rolled cake mould - triangle & half circle	Cod.	L x W cm	H cm
	291201	48 x 6,5 ▲	7
	291202	48 x 6,5 ◐	7
	291204	48 x 5 ◐	4



Kit 2 stampi semifreddo rettangolari in plastica



Kit of 2 pcs. plastic semifreddo mould, rectang.	Cod.	L x W cm	H cm	Box
	291402	16 x 32,5	5,5	6
		15 x 26,5	4,5	



Kit 2 stampi semifreddo quadrati in plastica

Kit of 2 pcs. plastic semifreddo mould, square	Cod.	L x W cm	H cm	Box
	291407	28,5 x 24	5,5	6
		24,5 x 20	4,5	

**Stampo basso con tubo
in alluminio**

Aluminium shallow mould with tube	Cod.	Ø cm	H cm
  Cod. 291514	291514	14	5,1
	291522	22	6,9
	291524	24	7,6



**Stampo americano festonato
con tubo in alluminio**

Aluminium american mould festooned with tube	Cod.	Ø cm	H cm
	291722	22	12,5

**Stampo cassata
in alluminio**

Aluminium cassata mould	Cod.	Ø cm	H cm
  Cod. 291613	291612	12	10
	291613	13	10,7



**Stampo plumcake
in alluminio**

Aluminium plumcake mould	Cod.	L x W cm
	291826	26 x 7,6



**Stampo cassata conico
in alluminio**

Aluminium conical cassata mould	Cod.	Ø cm	H cm
	291614	10	10

**Tortiera conica alta
silverstone in alluminio
antiaderente**

Silverstone high conical cake tin in aluminium with non stick coating	Cod.	Ø cm	H cm
	291924	24	6,2
	291928	28	6,8

**Stampo zuccotto
in alluminio**

Aluminium 'Zuccotto' mould	Cod.	Ø cm	H cm
	291615	23	10,5



**Stampo tartelletta tondo
dritto in alluminio antiaderente**

Canapé mould round straight in aluminium with non stick coating	Cod.	Ø cm	H cm
	292070	7	1,8

**Stampo americano festonato con
tubo in alluminio**

Aluminium 'Gugelhopf' mould	Cod.	Ø cm	H cm
	2917124	12,5	5

**Stampo tartelletta rettangolare
dritto in alluminio antiaderente**

Canapé mould rectangular straight in aluminium with non stick coating	Cod.	L x W cm	H cm
	292195	9 x 5,1	1,4



CONFEZIONE
12
PEZZI/PIECES

**Stampo barchetta
in alluminio antiaderente**

Boat mould in aluminium with non stick coating	Cod.	L x W cm	H cm
	292280	8 x 3,3	1,2
	292299	10 x 4,3	1,3



**Stampo alto con tubo
in alluminio**

Aluminium high holed conical shaped mould	Cod.	Ø cm	H cm
	292720	20	21



CONFEZIONE
4
PEZZI/PIECES



**Stampo conico festonato
in alluminio**

Aluminium "Brioche" mould	Cod.	Ø cm	H cm
	2923134	12	6



**Stampo margherita
in alluminio**

Aluminium 'Daisy' mould	Cod.	Ø cm	H cm
	292820	20	8



**Stampo conico festonato alto
in alluminio**

Aluminium "Brioche" mould	Cod.	Ø cm	H cm
	292320	20	8



**Stampo diamante
in alluminio**

Aluminium 'Diamond' mould	Cod.	Ø cm	H cm
	292920	20	10



**Stampo conico festonato alto
in alluminio**

Aluminium "Brioche" mould	Cod.	Ø cm	H cm
	292413	13	10



CONFEZIONE
4
PEZZI/PIECES



**Stampo conico ricamato
in alluminio**

Aluminium shaped pudding mould	Cod.	Ø cm	H cm
	2930094	9,5	7



**Stampo pan brioche
in alluminio**

Aluminium Mould	Cod.	Ø cm	H cm
	292620	20	21



CONFEZIONE
4
PEZZI/PIECES



**Stampo budino senza orlo
conico in alluminio**

Aluminium conical shaped pudding mould	Cod.	Ø cm	H cm
	2931074	7	4





Stampo bombato ricamato in alluminio

Aluminium shaped pudding mould

Cod.	Ø cm	H cm
2932094	9,5	7



Stampo bombato slabbrato in alluminio

Aluminium chipped rim curved pudding mould

Cod.	Ø cm	H cm
2937094	9	4



Stampo budino s/orlo conico liscio in alluminio

Aluminium plain bottom pudding mould

Cod.	Ø cm	H cm
2933084	8	5



Stampo plumcake in alluminio

Aluminium plumcake mould

Cod.	L x W cm	H cm
2981084	9 x 6	4



Stampo monodose festonato in alluminio

Aluminium conical shaped mould

Cod.	Ø cm	H cm
2934084	8	8



Stampo bocconotto slabbrato in alluminio

Aluminium chipped rim oval pastry mould

Cod.	L x W cm	H cm
2938104	10 x 7	2



Stampo babà con orlo in alluminio

Aluminium rimmed babà

Cod.	Ø cm	H cm
2935084	8	9



Stampo bocconotto basso in alluminio

Aluminium low pastry mould

Cod.	Ø cm	H cm
2939064	6	2



Stampo budino senza orlo quadro in alluminio

Aluminium square pudding mould

Cod.	L x W cm
2936074	7 x 7



Stampo bocconotto alto in alluminio

Aluminium high pastry mould

Cod.	Ø cm	H cm
2940074	7	3,5





Set 2 tortiere coniche basse in alluminio

Set of 2 pcs aluminium low conical baking pan

Cod.	Ø cm	H cm
294398	22 - 24	2,9
294399	26 - 28	2,9



Tortiera fondo fiore in alluminio

Aluminium flower bottom baking-pan

Cod.	Ø cm	H cm
294114	14	3



Set 2 tortiere coniche alte in alluminio

Set of 2 pcs aluminium high conical baking pan

Cod.	Ø cm	H cm
294498	22 - 24	4,6
294499	26 - 28	4,6



Set 6 stampini pasticceria in alluminio

Kit of 6 pcs aluminium pastry moulds

Cod.	L x W cm
294299	6,5 x 4,5



Tortiera tonda alta bordo festonato in alluminio

Aluminium shaped edge round high baking pan

Cod.	Ø cm	H cm
294525	25	4



Tortiera conica bassa in alluminio

Aluminium low conical baking-pan

Cod.	Ø cm	H cm
294324	24	2,9



Tortiera tonda liscia bordo festonato in alluminio

Aluminium shaped edge round baking pan

Cod.	Ø cm	H cm
294624	24	2,3







Stampo plumcake in alluminio antiaderente

Plumcake mould in aluminium with non stick coating

Cod.	L x W cm	H cm
294926	26 x 13	8



Stampo madeleines multiplo antiaderente

Non sticking multiple madeleines mould

Cod.	L x W cm	H cm
295400	36 x 17	2



Stampo brioche piccolo coste grandi antiaderente

Non sticking small brioche mould

Cod.	Ø cm	H cm
2951806	8	3



Set 4 stampini pasticceria antiaderente

Kit of 4 pcs non sticking small pastry moulds

Cod.	H cm
295500	1,5



Stampo brioche alto antiaderente

Non sticking high fluted brioche mould

Cod.	Ø cm	H cm
2952806	8	4



Tortiera tonda bassa lamiera blu

Blue steel low round baking-pan

Cod.	Ø cm	H cm	Box
295601	22	2,5	6
295602	24	2,5	6
295603	26	2,5	6



Carta di 36 formine antiaderenti

Non sticking small pastry moulds - 36 pcs

Cod.	H cm
295800	2



Stampo ovale festonato antiaderente

Non sticking oval shaped mould

Cod.	L x W cm	H cm
2953104	10 x 4	4



Stampo per babà antiaderente

Non sticking babà mould

Cod.	Ø cm	H cm
2958014	6	7





Savarin bucata antiaderente

Non sticking savarin mould : Cod. Ø cm H cm
2958026 8 4



Savarin bucata antiaderente

Non sticking savarin mould : Cod. Ø cm H cm
296005 24 5



Millasson rotonda liscia antiaderente

Non sticking millasson mould : Cod. Ø cm H cm
2958036 9 2



Forma savarin con spirali antiaderente

Non sticking "trois freres" ring mould : Cod. Ø cm H cm
296006 22 5



Charlotte antiaderente

Non sticking charlotte : Cod. Ø cm H cm
296001 24 10



Forma per torta manqué antiaderente

Non sticking square mould : Cod. L x W cm H cm
296007 24 x 24 5



Diplomate/bavarois antiaderente

Non sticking bavarois : Cod. Ø cm H cm
296002 18 9



Forma per torta manqué antiaderente

Non sticking square mould : Cod. L x W cm H cm
296008 22 x 22 5



Placca pasta roll. bordata in alluminio antiaderente

Baking plate in aluminium with non stick coating : Cod. L x W cm H cm
296004 37 x 27 2

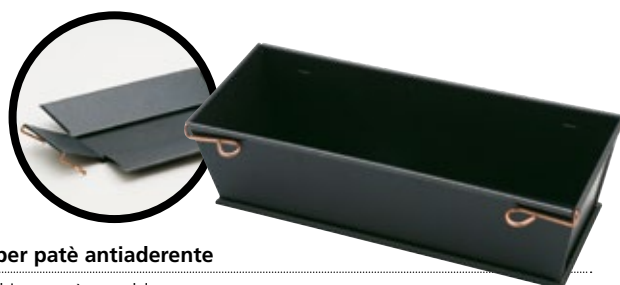

Forma per patè antiaderente

Non sticking paté mould : Cod. L x W cm H cm
296009 27 x 14 8





Forma tonda scanalata bassa antiaderente

Non sticking round mould, fluted edges	Cod.	Ø cm	H cm
	296120	20	3,5
	296140	28	3,5



Vassoio in polistirene con coperchio in PETG trasparente

Polystyrene tray with transparent PETG cover	Cod.	L x W cm	H cm
	297800	60 x 40	6



Forma tonda scanalata bassa antiad. fondo mobile

Non sticking round mould, fluted edges, loose bottom	Cod.	Ø cm	H cm
	296242	30	3,5
	296250	32	3,5



Alzata per torte rotonda in alluminio tubo centrale, 3 - 4 piani

Aluminium multiple cake stand - round	Cod.	Ø cm	Rip./Fl.
	298009	20-26-32	3
	298010	20-26-32-40	4

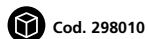

Tartelette rotonda scanalata antiaderente

Non sticking round fluted mould	Cod.	Ø cm	H cm
	29633012	6	2,5



Stampo decora crostate in plastica

Plastic stencil for grating pastry	Cod.	Ø cm	H cm
	298019	30	2



Forma torta bordo scanalato antiaderente, fondo mobile

Non sticking mould, fluted, loose bottom	Cod.	L x W cm	H cm
	296410	23 x 23	2,5
	296910	35 x 11	2,5



Stampo plumcake in alluminio

Aluminium plumcake mould	Cod.	L x W cm	H cm	Box
	2981084	9 x 6	4	3



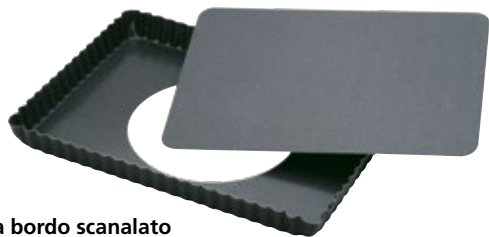

Forma torta bordo scanalato antiaderente, fondo mobile

Non sticking mould, fluted, loose bottom	Cod.	L x W cm	H cm
	298110	20,5 x 29	2,5



Tortiera tonda bordo liscio in latta

Tin plate round cake, loose bottom	Cod.	Ø cm	H cm
	298630	28	3



Alzata girevole in plastica per decorazione torte

Revolving cake stand, plastic	Cod.	Ø cm	H cm
	298200	32	11



Imbuto colatore inox manico e supporto in plastica

Automatic piston funnel - with plastic handle and stand	Cod.	Ø cm	Lt
	305300	20	0,9



Spatola flessibile poliamide antiaderente

Non sticking spatula	Cod.	L x W cm	Box
	298210	34 x 9	12



Imbuto colatore inox comprensivo di supporto

Stainless steel funnel strainer, support included	Cod.	Ø cm	Lt
	305400	20	1,5



Cod. 305400

305410 ghiera/spare part



Diplomate/bavarois ferro bianco

Tin plate diplomate mould	Cod.	Ø cm	H cm	Box
	298410	16	9	3



Supporto per imbuto colatore

Support for strainer filler	Cod.
	305500

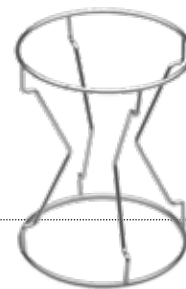

Forma tonda apribile ferro bianco con 2 fondi

Tin plate springform mould with 2 bottoms	Cod.	Ø cm	H cm
	298550	24	6

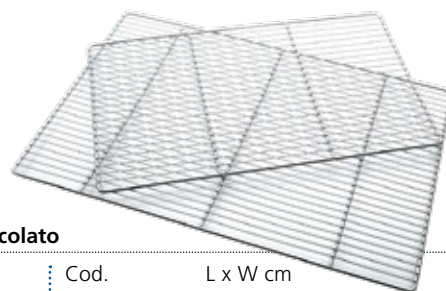

Griglia per colatoio per decorazione cioccolato

Flat rack for appliance to coat and to glaze	Cod.	L x W cm
	291053	53 x 32,5 GN 1/1
	291060	60 x 40
	291065	65 x 53 GN 2/1



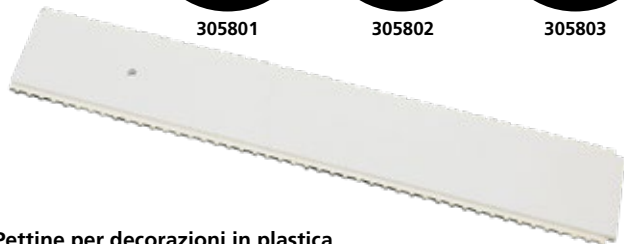
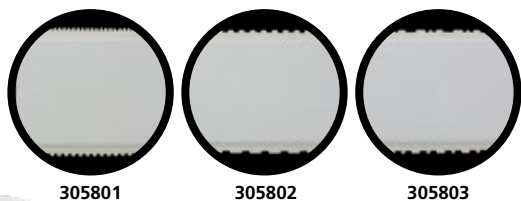

SPATOLARE IN MANIERA UNIFORME LA PASTA PER LA DECORAZIONE SUL TAPPETO ANTIADERENTE
SPREAD THE DECORATION PASTRY UNIFORMLY ON THE NON-STICK MAT

Pettine per decorazioni in plastica

Plastic comb for decoration	Cod.	L cm
	305801	70
	305802	70
	305803	70



APPOGGIARE IL PETTINE PER LA DECORAZIONE SUL FOGLIO E, TIRANDOLO NELLA DIREZIONE DESIDERATA, CREARE IL DECORO. PASSARE IN CONGELATORE
REST THE DECORATING COMB ON THE SHEET AND CREATE THE DECORATION BY DRAWING IT IN THE DESIRED DIRECTION. PUT INTO THE FREEZER



Telaio estensibile in acciaio inox

Stainless steel extensible frame	Cod.	L x W cm	H cm
	306101	30 x 30 → 57 x 56	4



STENDERE IN MANIERA UNIFORME LA PASTA PER IL BISCUIT. CUOCERE IN FORNO
SPREAD THE BISCUIT PASTRY UNIFORMLY. BAKE IN THE OVEN

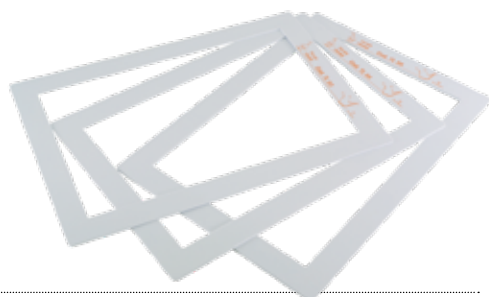

Telaio in plastica per stesura biscuit

Plastic frame for biscuit	Cod.	L x W cm	H mm
	306201	60 x 40	3
	306202	60 x 40	4
	306203	60 x 40	5



TOGLIERE, CON DELICATEZZA, IL TAPPETO ANTIADERENTE
CAREFULLY REMOVE THE NON-STICK MAT

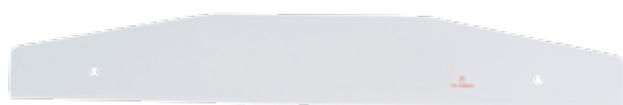

Spatola in plastica per biscuit

Special plastic adjustable spatula for biscuit	Cod.	L cm	H cm
	306300	56	8

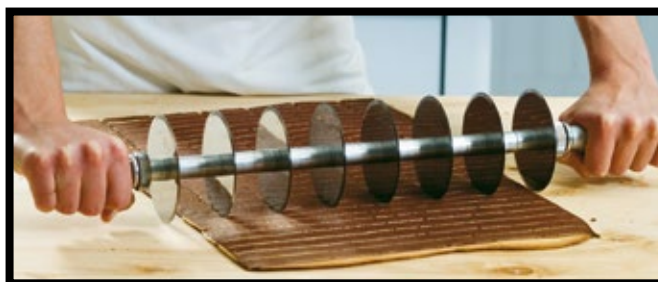

CON GLI APPOSITI TAGLIAPASTA REGOLABILI TAGLIARE IL PRODOTTO, CREANDO LE FASCE DI BISCUIT DELLA LARGHEZZA DESIDERATA
WITH THE SPECIAL ADJUSTABLE CUTTERS, CUT THE PRODUCT, CREATING BISCUIT STRIPS OF THE DESIRED WIDTH



Tappeto antiaderente per dolci - fiberlux

Non-stick baking mat - fiberlux -

Cod.	L x W cm
306400	60 x 40



Foglio pretagliato neutro

Precut paper

Cod.	L x W cm
306600	60 x 40

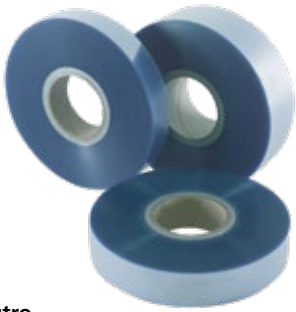

Nastro acetato neutro

Ribbon for mousse

Cod.	L m	H cm	T μ
309000	305	4	90





306808

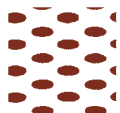

306810

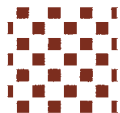

306811

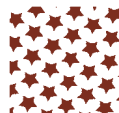

306812



307106



307107



307108



307115



306814



306817



307121



307128



307129



307139



307140



307144



307148

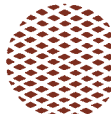

307149



307150



Mascherina in plastica per decorazione torta

Plastic mask for decoration	Cod.	Ø cm	Box
	307106	26	6
	307107	26	6
	307108	26	6
	307115	26	6
	307121	26	6
	307128	26	6
	307129	26	6
	307139	26	6
	307140	26	6
	307144	26	6
	307148	26	6
	307149	26	6
	307150	26	6

Griglia in plastica per decorazione biscuit

Plastic grill for decorated biscuit	Cod.	L x W cm
	306808	60 x 40
	306810	60 x 40
	306811	60 x 40
	306812	60 x 40
	306814	60 x 40
	306817	60 x 40



POSIZIONARE LA GRIGLIA SOPRA IL TAPPETO ANTIADERENTE E SPATOLARE IN MANIERA UNIFORME LA PASTA PER LA DECORAZIONE

POSITION THE GRILLE ABOVE THE NON-STICK MAT AND UNIFORMLY SPREAD THE PASTRY FOR DECORATION



SOLLEVARE CON DELICATEZZA LA GRIGLIA, LA VOSTRA DECORAZIONE È PRONTA PER ESSERE POSTA NEL CONGELATORE

GENTLY RAISE THE GRILLE. YOUR DECORATION IS READY TO BE PLACED IN THE FREEZER



307204



307213

Mascherina in plastica per decorazione krapfen

Plastic mask for doughnut decoration	Cod.	Ø cm	Box
	307204	12	6
	307213	12	6



Serie 10 mascherine stencil per cappuccino

10 Plastic mask for 'Cappuccino' decoration	Cod.	Ø cm
	307400	9,5



Alzata per dolci

Cake stand	Cod.	Ø cm	H cm
	420424	24	9



Espositore per torta

Cake stand	Cod.	Ø cm	H cm
	420507	20	7
	420511	20	11
	420515	20	15
	420607	25	7
	420611	25	11
	420615	25	15
	420707	30	7
	420711	30	11
	420715	30	15





Anello inox tondo

Stainless steel tart ring	Cod.	Ø cm	H cm
	701210	10	2
	701212	12	2
	701214	14	2
	701218	18	2
	701220	20	2
	701222	22	2
	701226	26	2
	701228	28	2
	701230	30	2



Vassoio da vetrina oxalizzato

Display tray, oxalized aluminium	Cod.	L x W cm	H cm	Box
	705014	14,5 x 23	1,5	3
	705018	18 x 30	1,5	3
	705022	22,5 x 30	1,5	3
	705024	24,5 x 37,5	1,5	3



Vassoio da vetrina anodizzato

Display tray, anodized aluminium gold	Cod.	L x W cm	H cm	Box
	705114	14,5 x 23	1,5	3
	705118	18 x 30	1,5	3
	705122	22,5 x 30	1,5	3
	705124	24,5 x 37,5	1,5	3



Fagioli di ceramica per cottura base torta

Baking beans	Cod.
	701300



Anello inox tondo

Stainless steel mousse ring	Cod.	Ø cm	H cm
	701410	10	4
	701412	12	4
	701414	14	4
	701418	18	4
	701420	20	4
	701422	22	4
	701426	26	4
	701428	28	4
	701430	30	4



Quadrato inox

Stainless steel square	Cod.	Ø cm	H cm
	705418	18 x 18	4
	705420	20 x 20	4
	705422	22 x 22	4
	705424	24 x 24	4
	705426	26 x 26	4
	705428	28 x 28	4

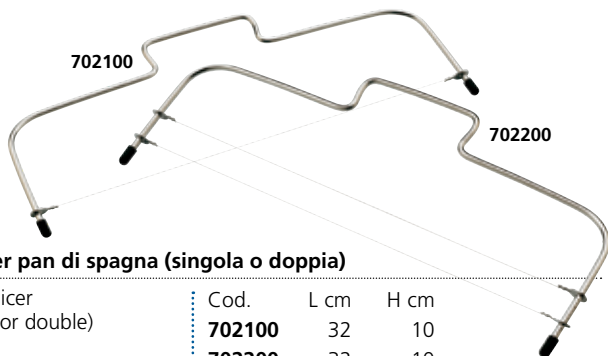

Lira per pan di spagna (singola o doppia)

Cake slicer (single or double)	Cod.	L cm	H cm
	702100	32	10
	702200	32	10





TAVOLA

TABLEWARE

LINEE POSATERIA CUTLERY LINES	142
POSATERIA SPECIALE SPECIAL CUTLERY	146
COMPLEMENTI TAVOLA TABLE COMPLEMENTS	148
VASSOI TRAYS	152
ACCESSORI TAVOLA TABLE ACCESSORIES	154
CESTINI BASKETS	156
MESTOLAME LADLE LINE	157



310001



310021



310031



310002



310022



310033



310003



310023



310034



310004

Parigi



	Cod.	L cm	T mm
Cucchiaino moka Moka spoon	310004	11,5	3
Cucchiaino thé e caffè Tea spoon	310003	14	3
Cucchiaino frutta Dessert spoon	310002	18	3
Cucchiaio tavola Table spoon	310001	20,6	3
Forchetta tavola Table fork	310021	20,6	3
Forchetta frutta Dessert fork	310022	18	3
Forchetta pesce Fish fork	310023	18	3
Coltello tavola Table knife	310031	23,8	3
Coltello frutta Dessert knife	310033	21	3
Coltello pesce Fish knife	310034	21	3



IL CODICE IN COLORE INDICA CHE LA CONFEZIONE CONTIENE 12 PEZZI
THE COLOR CODE INDICATES THAT THE PACKAGE CONTAINS 12 PIECES



310101



310121



310131



310102



310122



310133



310103



310123



310134



310104



310124



310150

Vienna

	Cod.	L cm	T mm
Cucchiaino tavola Table spoon	310101	20,6	3
Cucchiaino frutta Dessert spoon	310102	18	3
Cucchiaino thé e caffè Tea spoon	310103	14	3
Cucchiaino moka Moka spoon	310104	11,5	3
Forchetta tavola Table fork	310121	20,6	3
Forchetta frutta Dessert fork	310122	18	3
Forchetta pesce Fish fork	310123	18	3
Forchettina torta Cake fork	310124	16,5	3
Coltello tavola Table knife	310131	23,8	3
Coltello frutta Dessert knife	310133	21	3
Coltello pesce Fish knife	310134	21	3
Pala torta Cake server	310150	26	3



IL CODICE IN COLORE INDICA CHE LA CONFEZIONE CONTIENE 12 PEZZI
THE COLOR CODE INDICATES THAT THE PACKAGE CONTAINS 12 PIECES



Roma



	Cod.	L cm	T mm
Cucchiaino tavola Table spoon	310201	20,6	3
Cucchiaino frutta Dessert spoon	310202	18	3
Cucchiaino thé e caffè Tea spoon	310203	14	3
Cucchiaino moka Moka spoon	310204	11,5	3
Palettina gelato Ice cream spoon	310205	13,7	3
Cucchiaino bibita Cocktail spoon	310207	20	3
Forchetta tavola Table fork	310221	20,6	3
Forchetta frutta Dessert fork	310222	18	3
Forchetta pesce Fish fork	310223	18	3
Forchettina torta Cake fork	310224	16,5	3
Coltello tavola Table knife	310231	23,8	3
Coltello frutta Dessert knife	310233	21	3
Coltello pesce Fish knife	310234	21	3
Spalmaburro Butter spreader	310235	17	3
Coltello bistecca Steak knife	310236	25	3
Pala torta Cake server	310250	26	3
Cucchiaino legumi Vegetable spoon	310251	23	3
Forchettone legumi Vegetable fork	310252	23	3
Posate insalata Salad servers	310253	23	3
Mestolo a servire Serving ladle	310254	27	3
Mestolo salsa Gravy ladle	310255	17,7	3



IL CODICE IN COLORE INDICA CHE LA CONFEZIONE CONTIENE 12 PEZZI
THE COLOR CODE INDICATES THAT THE PACKAGE CONTAINS 12 PIECES



310301



310302



310303



310304



310321



310322



310323



310324



310331



310333



310334



310335



310336



310350



310351



310352

Copenhagen

Design by Michele Capuani

	Cod.	L cm	T mm
Cucchiaino tavola Table spoon	310301	20,6	3
Cucchiaino frutta Dessert spoon	310302	18,7	3
Cucchiaino thé e caffè Tea spoon	310303	15	3
Cucchiaino moka Moka spoon	310304	12,3	3
Forchetta tavola Table fork	310321	20,6	3
Forchetta frutta Dessert fork	310322	18,6	3
Forchetta pesce Fish fork	310323	19,1	3
Forchettina torta Cake fork	310324	16,5	3
Coltello tavola Table knife	310331	23,2	3
Coltello frutta Dessert knife	310333	21	3
Coltello pesce Fish knife	310334	21,3	3
Spalmaburro Butter spreader	310335	16,3	3
Coltello bistecca Steak knife	310336	24,2	3
Pala torta Cake server	310350	26,5	3
Cucchiaino legumi Vegetable spoon	310351	26	3
Forchettone legumi Vegetable fork	310352	26	3



CONFEZIONE
12
PEZZI

IL CODICE IN COLORE INDICA CHE LA CONFEZIONE CONTIENE 12 PEZZI
THE COLOR CODE INDICATES THAT THE PACKAGE CONTAINS 12 PIECES

**Pala per torta a coltello unipezzo**

Decorated pie server	Cod.	L cm
	320000	31

**Pala per torta unipezzo**

Decorated pie server	Cod.	L cm
	320200	30

**Pala per torta a lama dentellata unipezzo**

Serrated decorated pie server	Cod.	L cm
	320300	30

**Pala per torta unipezzo**

Pie server	Cod.	L cm
	320400	31

**Pala per torta triangolare manico bianco**

Pie server white handle	Cod.	L cm
	3205001	25

**Pala per torta triangolare**

Pie server	Cod.	L cm
	320600	25

**Pala per pasta al forno**

Gratin server	Cod.	L cm
	320800	29
	3208001	29



Cod. 3208001



Cucchiione per servire

Serving spoon	Cod.	L cm	Finitura/Finishing
	320900	26	Lucido/Bright
	320901	26	Lucido ornato/Bright decorat.
	320902	26	Satinato ornato/Matt decorat.



Forchetta per ostrica

Oyster fork	Cod.	L cm
	321500	15

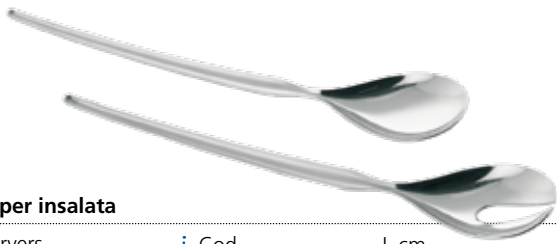

Posate per insalata

Salad servers	Cod.	L cm
	3211001	27,5



Forchetta scavino per aragosta

Lobster pick	Cod.	L cm
	321600	20



Mestolino per sugo, tipo normale

Sauce ladle	Cod.	L cm
	321200	16



Pinza per aragosta

Lobster pincer	Cod.	L cm
	321700	18,5
	3217001	18,5



Cod. 3217001



Mestolino per sugo con separatore grasso/magro

Sauce ladle fat separator	Cod.	L cm
	321201	16



Cucchiaino per marmellata

Jam spoon	Cod.	L cm
	321800	19



Forchettina per lumache

Snail fork	Cod.	L cm
	321400	14



Cucchiaino per bibita

Beverage spoon	Cod.	L cm
	321900	20



Servizio per olio, aceto, sale, pepe, stecchi in filo

Condiment set 5 pcs - wire handle
Cod. **330000**



Servizio per olio, aceto, sale, pepe in filo

Condiment set 4 pcs - wire handle
Cod. **330100**



Servizio olio e aceto in filo

Oil & vinegar set 2 pcs - wire handle
Cod. **330200**



Servizio per sale e pepe in filo

Salt & pepper set 2 pcs - wire handle
Cod. **330300**



Servizio per sale, pepe, stecchi in filo

Salt/pepper/toothpick set - wire handle
Cod. **330400**



Formaggiera in filo

Parmesan cheese cellar
Cod. **330500**



Tappi olio, aceto, spargisale, spargipepe

Oil, vinegar, salt and pepper caps
Cod. **330700**
330800
330900



Portastecchi

Toothpick holder
Cod. **331100**



Vetro formaggiera, vetro olio e aceto, vetro sale e pepe

Cheese cellar glass, oil and vinegar glass, salt and pepper glass
Cod. **331200**
331300
331400

Box
6
6
12

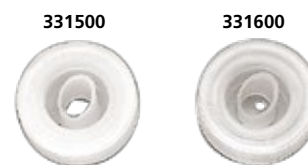

Tappo versatore aceto e olio

Vinegar and oil pourer
Cod. **331500**
331600

Box
4
4





Cestino liscio quadrato

Plain basket

Cod.	L x W cm
340018	18 x 18
340023	23 x 23



Cestino traforato quadrato

Open-worked basket

Cod.	L x W cm
340118	18 x 18
340123	23 x 23



Cestino liscio rettangolare

Plain basket

Cod.	L x W cm
340224	24 x 18
340227	27 x 20



Cestino traforato rettangolare

Open-worked basket

Cod.	L x W cm
340324	24 x 18
340327	27 x 20



Cestino per servire

Basket

Cod.	L x W cm
340530	30 x 17



Sottopiatto

Under plate

Cod.	Ø cm
340630	30



Insalatiera - bacinella

Bowl

Cod.	Ø cm
340713	13
340719	19
340723	23



Insalatiera - bacinella

Bowl

Cod.	Ø cm
340912	12,5
340917	17
340919	19
340921	21





Legumiera

Vegetable dish

Cod.	Ø cm	cl
341311	11	35
341313	13	50
341316	16	80
341318	18,5	120
341320	20	150
341322	22	200
341324	24	250
341326	26	300



Zuppiera

Soup-tureen

Cod.	Ø cm	cl
341516	16	80
341518	18,5	130
341520	20	175
341522	22	225
341524	24	300
341526	26	400
341530	30	600



Coperchio per legumiera e zuppiera

Lid for vegetable dish and soup-tureen

Cod.	Ø cm
341711	11
341713	13
341716	16
341718	18
341720	20
341722	22
341724	24
341726	26
341730	30



Salsiera

Sauce-boat

Cod.	cl
341915	15
341925	25
341935	35
341950	50



Piatto da portata ovale con bordo

Oval serving plate

Cod.	L x W cm
350235	35 x 24
350240	40 x 27
350245	45 x 32
350250	50 x 35
350260	60 x 37



Piatto tondo

Round dish

Cod.	Ø cm
350354	54



Piatto da portata tondo con bordo

Round dish

Cod.	Ø cm
350412	12,5
350416	16
350426	26
350430	30
350434	34
350437	37
350445	45



Salsiera con separatore grasso/magro

Sauce-boat fat separator

Cod.	cl
342015	15





Piatto da portata ovale con bordo

Oval serving plate

Cod.	L x W cm
350627	27 x 20
350632	32 x 22,5
350637	37 x 25
350642	42 x 28
350647	47 x 31,5
350652	52 x 35
350658	58 x 37
350664	64 x 40



Teglia ovale per gratin per servire

Serving dish

Cod.	L x W cm	H cm
350838	38 x 22,5	5,5
350843	43 x 25,5	6
350848	48 x 27	6,5
350855	55 x 30,5	6,5



Campana per piatto da portata ovale

Plate cover

Cod.	L x W cm	H cm
350954	54 x 33	11
350959	59 x 36	11

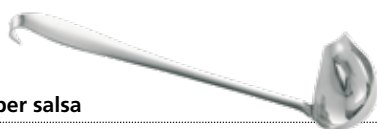

Mestolino ovale per salsa

Oval sauce ladle

Cod.
430600



COMPOSIZIONE DEL SET
SET COMPOSITION

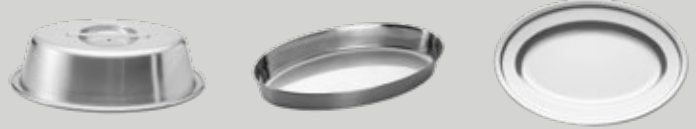
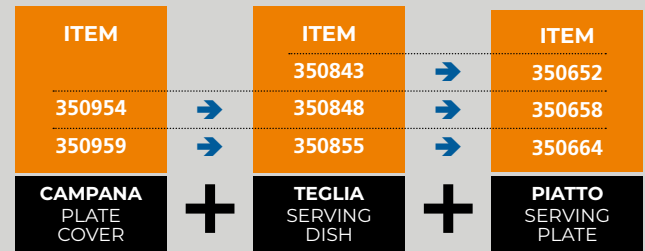



Piatto da pesce con bordo

Fish dish	Cod.	L x W cm
	351040	40 x 20
	351055	55 x 24



Vassoio rettangolare per bar in acciaio

Rectangular steel bar tray	Cod.	L x W cm
	360025	25 x 19,5
	360029	29 x 22
	360034	34 x 27
	360040	40 x 32
	360046	46 x 35
	360052	52 x 38
	360060	60 x 45



Vassoio rettangolare per bar in acciaio con maniglie

Rectangular steel bar tray with handles	Cod.	L x W cm
	360240	40 x 32
	360246	46 x 35
	360252	52 x 38
	360260	60 x 45



Vassoio ovale per bar in acciaio

Oval steel bar tray	Cod.	L x W cm
	360419	19 x 14
	360423	23 x 18
	360426	26 x 20



Vassoio rettangolare laminato antiscivolo

Rectangular laminated tray with non slip treatment	Cod.	L x W cm	Box
	361000	37 x 53 EN	12
	361100	32,5 x 53 GN 1/1	12
	361200	36 x 46	12
	361300	32 x 44	12
	361400	33 x 43	12
	361500	24,5 x 34	12
	361600	28 x 20	12



Vassoio rettangolare laminato

Rectangular laminated tray	Cod.	L x W cm	Box
	361001	37 x 53 EN	12
	361101	32,5 x 53 GN 1/1	12
	361201	36 x 46	12
	361501	24,5 x 34	12



Vassoio trapezoidale laminato antiscivolo

Trapezoidal laminated tray with non slip treatment	Cod.	L x W cm	Box
	362500	36 x 52	12



Vassoio trapezoidale laminato

Trapezoidal laminated tray	Cod.	L x W cm	Box
	362501	36 x 52	12



Vassoio trapezoidale laminato antiscivolo

Trapezoidal laminated tray with non slip treatment	Cod.	L x W cm	Box
	362600	33 x 47	12





Vassoio ovale laminato antiscivolo

Oval laminated tray with non slip treatment	Cod.	L x W cm	Box
	363000	27 x 38	12
	363100	20 x 26,5	12



Vassoio rotondo laminato antiscivolo

Round laminated tray with non slip treatment	Cod.	Ø cm	Box
	363500	43	12
	363600	38	12
	363700	32	12



Vassoio rettangolare KAU Polyform antiscivolo

Rectangular KAU Polyform tray with non slip treatment	Cod.	L x W cm	Box
	364000	37 x 53 EN	12
	364100	32,5 x 53 GN 1/1	12



Vassoio ovale KAU Polyform antiscivolo

Oval KAU Polyform tray with non slip treatment	Cod.	L x W cm	Box
	365000	21 x 29	12



Vassoio rotondo KAU Polyform antiscivolo

Round KAU Polyform tray with non slip treatment	Cod.	Ø cm	Box
	365500	36	12



Vassoio rettangolare Rubberform antiscivolo

Rectangular Rubberform tray with non slip treatment	Cod.	L x W cm	Box
	366001	37 x 53 EN	12
	366101	32,5 x 53 GN 1/1	12
	366201	36 x 46	12
	366301	33 x 43	12
	366401	20 x 28	12
	366501	26,5 x 32,5 GN 1/2	12



Vassoio ovale Rubberform antiscivolo

Oval Rubberform tray with non slip treatment	Cod.	L x W cm	Box
	367001	21 x 29	12
	367101	20 x 26,5	12
	367301	44 x 58	12



Vassoio rotondo Rubberform antiscivolo

Round Rubberform tray with non slip treatment	Cod.	Ø cm	Box
	367501	43	12
	367601	38	12
	367701	32	12



Vassoio rettangolare in poliestere rinforzato

Oval reinforced tray in polyester	Cod.	L x W cm	Box
	368000	37 x 53 EN	12
	368100	32,5 x 53 GN 1/1	12
	368200	36 x 46	12
	368300	26,5 x 32,5 GN 1/2	12



Vassoio ovale in poliestere rinforzato

Oval reinforced tray in polyester	Cod.	L x W cm	Box
	368500	21 x 29	12





Tegamino per uova

Egg frying pan

Cod. **370019** Ø cm 19



Raccogliatrice

Crumb sweeper

Cod. **370700**



Piatto per lumache 6 posti

Snail dish - six holes

Cod. **370100**



Raccogliatrice

Crumb sweeper

Cod. **370800**



Piatto per lumache 6 posti

Snail dish - six holes

Cod. **370200**



Accessorio per piatti set 4 pezzi

Fish-bone tray - set 4 pcs.

Cod. **370900**



Piatto per lumache 12 posti

Snail dish - six holes

Cod. **370300**



Portauova

Egg cup

Cod. **371000**



Portastecchi

Tooth-pick holder

Cod. **370600**



Portauova

Egg cup

Cod. **371100**



**Tagliatartufi inox classico
lama diritta**

Truffle-slicer, stainless steel
plain blade - classic

Cod. **375100**



**Tagliatartufi inox manico
ulivo lama ondulata**

Truffle-slicer, stainless steel
corrugated blade,
olive handle

Cod. **375500**



Liquido riscaldante per chafing dish

Heating liquid
for chafing dish

Cod. **410601**

Note
6 ore / 6 hours



Ricambio per porta alcool solido

Fuel holder

Cod. **410650**



**Riscaldatore elettrico
per chafing dish**

Electric heater
for chafing dish

Cod. **410700**

L x W cm
30 x 20



**Riscaldatore elettrico
per chafing dish con termostato**

Electric heater with
thermostat for chafing dish

Cod. **410705**

L x W cm
30 x 20



Conchiglia in plastica

Plastic shell

Cod. **411701**
411702

Col. cl
○ 490
● 490



**Terrina rotonda
in policarbonato**

Round polycarbonate
bowl

Cod. **411801**
411802
411803
411804

Ø cm cl Box
20 200 12
25 300 12
30 500 12
38 1000 4





Cesta da buffet rotonda, struttura in acciaio cromato e midollino sintetico, cloche roll top, lavabile

Round buffet basket, stainless steel structure, poly rattan weave, roll top cover, washable

Cod.	Ø cm	H cm
425600		



Cesta da buffet rotonda, struttura in acciaio cromato e midollino sintetico, lavabile

Round buffet basket, stainless steel structure, poly rattan weave, washable

Cod.	Ø cm	H cm
425601	48	13



Cesta da buffet rettangolare, struttura in acciaio cromato e midollino sintetico, lavabile

Rectangular buffet basket, st. steel structure, poly rattan weave, washable

Cod.	L x W cm	H cm
425701	36 x 57	13



Cesta da buffet quadrata in polipropilene, lavabile

Square buffet basket in polypropylene, washable

Cod.	L x W cm	H cm	Box
428000	50 x 52	14-24	6



Cesta da buffet in polipropilene, rotonda con manici, lavabile

Round buffet basket in polypropylene with handles, washable

Cod.	Ø cm	H cm	Box
428200	42	19	6



Cestino portapane rotondo in polipropilene, lavabile

Round bread basket in polypropylene, washable

Cod.	Ø cm	H cm	Box
428300	23	8	12



Cestino portapane ovale in polipropilene, lavabile

Oval bread basket in polypropylene, washable

Cod.	L x W cm	H cm	Box
428400	25 x 17	8,5	12



Cestino portapane ovale in polipropilene, lavabile

Oval bread basket in polypropylene, washable

Cod.	L x W cm	H cm	Box
428600	28 x 16	8	12



Ciotola vetro

Glass bowl

Cod.	Ø cm
456400	23
456402	Coperchio 2 parti/Opening lid



**Cucchiaine**

Basting spoon

Cod.
431900**Asta appendimestoli**

Hanging bar

Cod.
432038 L cm
38**Mestolo manico filo**

Ladle wire handle

Cod.
432309 Ø cm
9**Schiumarola manico filo**

Skimmer wire handle

Cod.
432400 Ø cm
11**Paletta rettangolare manico filo**

Rectang. lifter wire handle

Cod.
432500 L x W cm
7,5 x 9,5**Forchettone manico filo**

Meat fork wire handle

Cod.
432600**Cucchiaine manico filo**

Basting spoon wire handle

Cod.
432700**Schiumarola a rete manico filo**

Mesh skimmer wire handle

Cod.
432800 Ø cm
12



BAR

MOLLE BAR - TAPPI VERSATORI BAR TONGS - POURERS	160
VASSOI BAR BAR TRAYS	164
CAFFETTERIA - GELATERIA COFFEE AND TEA POTS - ICE CREAM SHOP	166
SHAKER, COLINI, MIXING GLASS SHAKERS, STRAINERS, MIXING GLASSES	172
JIGGERS	176
MUGS	178
ACCESSORI BAR BAR ACCESSORIES	180
PESTELLI E CANNUCCE PESTLES AND STRAWS	196
APPARECCHI ELETTRICI ELECTRICAL APPLIANCES	198



Molla per ghiaccio

Ice cube tongs	Cod.	L cm	Box
	010400	18	12



Molla frutta

Design by Michele Capuani

Fruit tongs	Cod.	L cm	Box
	014500	30	12
	014515	15	12
	014523	23,5	12



Molla per ghiaccio

Ice cube tongs	Cod.	L cm	Box
	011100	20	12



Molla frutta 40°

Design by Michele Capuani

40° fruit tongs	Cod.	L cm	Box
	014600	30	12
	014615	15	12
	014623	23,5	12



Molla per ghiaccio

Ice cube tongs	Cod.	L cm	Box
	011500	16	12



Molla frutta in nylon & fiberglass

Design by Michele Capuani

Nylon & fiberglass fruit tongs	Cod.	L cm	Box
	01833000	30	12

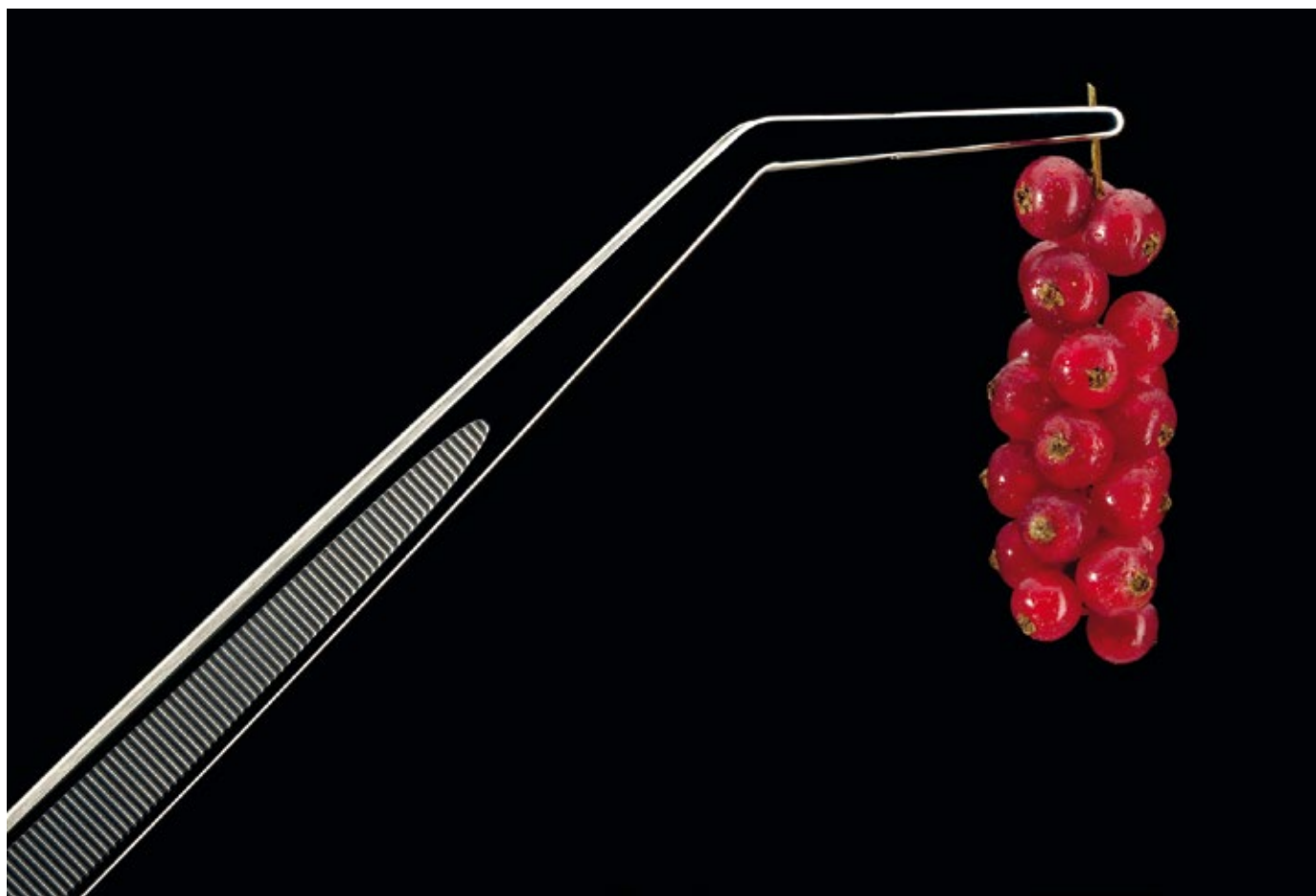



ADATTO A
SUITABLE FOR
Ø mm 17,5 > 18

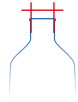

Design by Marco Valente

**Tappo versatore con
silicone Design-Pourer**

Design-Pourer silicone gear Cod. **050800**



ADATTO A
SUITABLE FOR
Ø mm 17,5 > 18

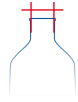

Design by Marco Valente

**Tappo versatore con
silicone Tech-Pourer**

Tech-Pourer silicone gear Cod. **0509004**

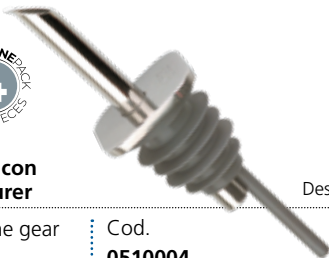

ADATTO A
SUITABLE FOR
Ø mm 17,5 > 18

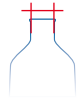

Design by Marco Valente

**Tappo versatore con
silicone Tech-Pourer**

Tech-Pourer silicone gear Cod. **0510004**

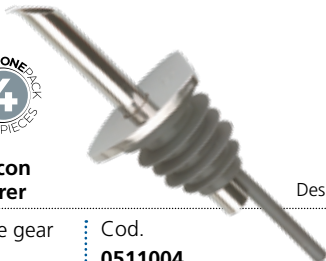

ADATTO A
SUITABLE FOR
Ø mm 17,5 > 18

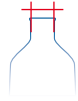

Design by Marco Valente

**Tappo versatore con
silicone Tech-Pourer**

Tech-Pourer silicone gear Cod. **0511004**

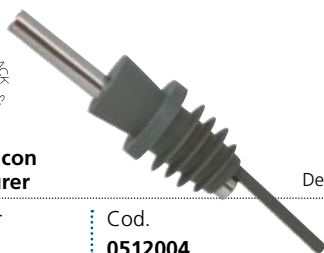

ADATTO A
SUITABLE FOR
Ø mm 17,5 > 18



Design by Marco Valente

**Tappo versatore con
silicone Soft-Pourer**

Pourer Soft-Pourer Cod. **0512004**



ADATTO A
SUITABLE FOR
Ø mm 17,5 > 18



Design by Marco Valente

**Tappo versatore con
silicone Soft-Pourer**

Pourer Soft-Pourer Cod. **0513004**

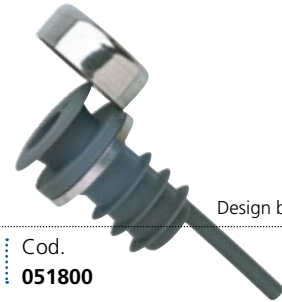

ADATTO A
SUITABLE FOR
Ø mm 17,5 > 18

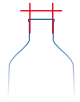

Design by Marco Valente

**Tappo versatore
per vino con chiusura**

Closable wine-pouring stopper Cod. **051800**



Box
18



ADATTO A
SUITABLE FOR
Ø mm 17,5 > 18



**Tappo versatore dosatore
in acciaio inox**

Measuring stainless steel pourer Cod. **05321012**



ADATTO A
SUITABLE FOR
Ø mm 17,5 > 18



**Tappo versatore dosatore
inox con chiusura**

Measuring stainless steel pourer with lid Cod. **05325012**



BPour, tester per dosaggi

BPour, pour check Cod. **053290** Ø cm 10,5 H cm 16,5





Cod. 0533002



Cod. 0533006

ADATTO A
SUITABLE FOR
Ø mm 18,5 > 21**Tappo versatore SteadySpout 2.0**

SteadySpout 2.0 pourer

Cod.

0533002

Cod. 0533006

0533006

STEADYSPOUT^{2.0}

THE EVOLUTION OF THE METAL POURER

Con SteadySpout avrai un versaggio sempre costante a 157BPM, l'unità di misura usata dai bartender per calibrare perfettamente la quantità di liquido nella preparazione dei cocktail.

INALTERABILE

La speciale plastica dotata di "memoria" torna alla forma originale con un passaggio in lavastoviglie.

ROBUSTO

Composto da 2 soli pezzi invece che 4.

Più solido e più resistente all'usura.

Maggiore durata nel tempo rispetto ai diretti concorrenti.

PRECISO

Velocità d'uscita del liquido garantita dalla presa d'aria. Nessuna goccia sia all'inizio che alla fine del versaggio. Ideale per la tecnica del jumping.

UNIVERSALE

Disegno e materiale delle lamelle offrono massima presa e inserimento/disinserimento facile e veloce.

Il doppio modulo di diametro lo rende adatto a bottiglie con collo da Ø18 a Ø21,5 mm.

BREVETTATO

Concepito, studiato e interamente progettato dall'ufficio tecnico di PIAZZA. 100% Made in Italy.

CARATTERISTICHE TECNICHE

- Cannuccia in acciaio inox 18/10 AISI 304 con lavorazione al laser
- Diametro, rastrematura e inclinazione della cannuccia perfettamente calibrati sia all'interno che all'esterno
- Lavabile in lavastoviglie

TECHNICAL SPECIFICATIONS

- Reed in AISI 304 18/10 laser processed stainless steel
- Perfectly calibrated diameter, tapering and inclination of the reed, both inside and outside
- Dishwasher friendly

With SteadySpout, the rate of pouring is always constant at 157BPM, the unit of measurement used by bartenders to perfectly calibrate the quantity of liquid in the preparation of cocktails.

NEVER CHANGES

Special plastic with "memory" returns to the original shape simply by putting it through the dishwasher.

STURDY

Composed of only 2 pieces rather than 4.

Sturdier and more resistant to wear and tear.

Longer duration compared to the other competitors.

ACCURATE

Pouring speed of the liquid guaranteed by the air intake. No spills either at the start or end of the pouring.

Perfect for the jumping technique.

UNIVERSAL

Design and material of the reed valves offer maximum grip and an easy and fast plugging/unplugging.

The double diameter module makes it suitable for bottles with necks of diameters from Ø18 to Ø21.5 mm.

PATENTED

Conceived, developed and entirely designed by PIAZZA's technical office. Entirely manufactured in Italy



FEEL THE BEAT
MIX THE DRINKS



SCOPRI COME
LO PRODUCIAMO
DISCOVER HOW
WE MANUFACTURE IT



Tappo versatore metrico

Metric pourer	Cod.	ml	Col.
	0540153	15	●
	0540203	20	●
	0540253	25	●
	0540303	30	●
	0540353	35	●
	0540403	40	●
	0540503	50	○



Riga limone

Lemon grater	Cod.	L cm
	163400	14



Decora limone

Lemon decorator	Cod.	L cm
	163500	14,5



Sbuccia arancia

Orange peeler	Cod.	L cm
	163700	14,5



Cucchiaino per bibita

Beverage spoon	Cod.	L cm	T mm	Box
	310207	20	3	12



Scavino 2 coppe

Melon baller-double	Cod.	L cm
	164100	16,5



Scavino 1 coppa

Melon baller	Cod.	L cm
	164200	13



Set decorazione cocktail - 7 pezzi

Cocktail decoration set 7 pieces	Cod.
	8151-9100G7001

- 
COLTELLO
KNIFE
- 
LEVATORSOLO
APPLE CORER
- 
SBUCCIA ARANCIA
ORANGE PEELER
- 
RIGA LIMONE
LEMON GRATER
- 
SCAVINO MELONE
MELON BALLER
- 
DECORA LIMONE
LEMON DECORATOR
- 
COLTELLO PER PELARE
PEELING KNIFE



Cucchiaino per bibita

Beverage spoon	Cod.	L cm	Box
	321900	20	6





Vassoio rettangolare per bar in acciaio

Rectangular steel bar tray

Cod.	L x W cm
360025	25 x 19,5
360029	29 x 22
360034	34 x 27
360040	40 x 32
360046	46 x 35
360052	52 x 38
360060	60 x 45



Vassoio rettangolare per bar in acciaio con maniglie

Rectangular steel bar tray with handles

Cod.	L x W cm
360240	40 x 32
360246	46 x 35
360252	52 x 38
360260	60 x 45



Vassoio ovale per bar in acciaio

Oval steel bar tray

Cod.	L x W cm
360419	19 x 14
360423	23 x 18
360426	26 x 20



Vassoio rettangolare laminato antiscivolo

Rectangular laminated tray with non slip treatment

Cod.	L x W cm	Box
361000	37 x 53 EN	12
361100	32,5 x 53 GN 1/1	12
361200	36 x 46	12
361300	32 x 44	12
361400	33 x 43	12
361500	24,5 x 34	12
361600	28 x 20	12



Vassoio rettangolare laminato

Rectangular laminated tray

Cod.	L x W cm	Box
361001	37 x 53 EN	12
361101	32,5 x 53 GN 1/1	12
361201	36 x 46	12
361501	24,5 x 34	12



Vassoio trapezoidale laminato antiscivolo

Trapezoidal laminated tray with non slip treatment

Cod.	L x W cm	Box
362500	36 x 52	12



Vassoio trapezoidale laminato

Trapezoidal laminated tray

Cod.	L x W cm	Box
362501	36 x 52	12



Vassoio trapezoidale laminato antiscivolo

Trapezoidal laminated tray with non slip treatment

Cod.	L x W cm	Box
362600	33 x 47	12





Vassoio ovale laminato antiscivolo

Oval laminated tray with non slip treatment	Cod.	L x W cm	Box
	363000	27 x 38	12
	363100	20 x 26,5	12



Vassoio rotondo laminato antiscivolo

Round laminated tray with non slip treatment	Cod.	Ø cm	Box
	363500	43	12
	363600	38	12
	363700	32	12



Vassoio rettangolare KAU Polyform antiscivolo

Rectangular KAU Polyform tray with non slip treatment	Cod.	L x W cm	Box
	364000	37 x 53 EN	12
	364100	32,5 x 53 GN 1/1	12



Vassoio ovale KAU Polyform antiscivolo

Oval KAU Polyform tray with non slip treatment	Cod.	L x W cm	Box
	365000	21 x 29	12



Vassoio rotondo KAU Polyform antiscivolo

Round KAU Polyform tray with non slip treatment	Cod.	Ø cm	Box
	365500	36	12



Vassoio rettangolare Rubberform antiscivolo

Rectangular Rubberform tray with non slip treatment	Cod.	L x W cm	Box
	366001	37 x 53 EN	12
	366101	32,5 x 53 GN 1/1	12
	366201	36 x 46	12
	366301	33 x 43	12
	366401	20 x 28	12
	366501	26,5 x 32,5 GN 1/2	12



Vassoio ovale Rubberform antiscivolo

Oval Rubberform tray with non slip treatment	Cod.	L x W cm	Box
	367001	21 x 29	12
	367101	20 x 26,5	12
	367301	44 x 58	12



Vassoio rotondo Rubberform antiscivolo

Round Rubberform tray with non slip treatment	Cod.	Ø cm	Box
	367501	43	12
	367601	38	12
	367701	32	12



Vassoio rettangolare in poliestere rinforzato

Oval reinforced tray in polyester	Cod.	L x W cm	Box
	368000	37 x 53 EN	12
	368100	32,5 x 53 GN 1/1	12
	368200	36 x 46	12
	368300	26,5 x 32,5 GN 1/2	12



Vassoio ovale in poliestere rinforzato

Oval reinforced tray in polyester	Cod.	L x W cm	Box
	368500	21 x 29	12





Cremiera

Design by Michele Capuani

Cream jug

Cod.	ml
460000	50



Spargicacao

Cocoa sprinkler

Cod.	H cm
470500	9



Lattiera

Design by Michele Capuani

Milk jug

Cod.	ml
460101	150
460103	250
460106	500
460109	750
460112	1000



Teiera

Design by Michele Capuani

Teapot

Cod.	ml
460301	150
460304	500
460306	750



Caffettiera

Design by Michele Capuani

Coffee jug

Cod.	ml
460203	250
460206	500
460212	1000



Lattiera

Milk jug

Cod.	ml
460503	250
460504	350
460506	500
460509	750
460512	1000









Coppa per punch e sangria

Punch bowl	Cod.	Ø cm	cl
	420800	32	700



Tazza per punch, bicchiere e tazza in vetro Jena

Punch & tea cup, glass and cup (Jena)	Cod.	cl	Box
	421100	16	6
	421200	22	6
	421300	16	6



Mestolino per ciliegie

Cherry ladle	Cod.	Ø cm	L cm
	430900	4	23



Mestolino per ciliegie con fori

Cherry ladle with holes	Cod.	Ø cm	L cm
	431000	4	23



Mestolino per ciliegie manico lungo

Cherry ladle	Cod.	Ø cm	L cm
	431100	4	28



Mestolino per ciliegie

Cherry ladle	Cod.	Ø cm	L cm
	431200	4	21,5



Mestolino per ciliegie con fori

Cherry ladle with holes	Cod.	Ø cm	L cm
	431300	4	21,5



Spremiagrumi

Citrus juicer

Cod.	Ø cm	cl
470700	13	50



Cucchiaio per cocktail

Cocktail spoon

Cod.	L cm
471200	15



Jigger

Double jigger

Cod.	ml
470812	scaled 20-30-50 30 x 60
470813	30 x 90
470823	60 x 90



Cucchiaino per bibita triangolare

Triangular long drink spoon

Cod.	L cm
4715246	24



Colino per cocktail

Cocktail strainer

Cod.	L cm
470900	16



Cucchiaino per bibita

Beverage spoon

Cod.	L cm
4716006	24



Agitatore

Stirring spoon

Cod.	L cm
471000	24



Spremiagitatore

Tonic stamper

Cod.	L cm
4719006	24



Cucchiaio per ghiaccio

Ice spoon

Cod.	L cm
471100	24



Forchettina bidente

Pickle fork

Cod.	L cm	Box
472000	12,5	12
4720006	12,5	



Cod. 4720006



Portacucchiaini

Moka spoon holder



Cod.	Ø cm	H cm
472100	7	8



Sbuccialimone manico bianco

Lemon peeler



Cod.	L cm
472600	14



Vaschetta lavaggio dosatori gelato

Rinsing basin



Cod.	Ø cm	H cm
472200	8,5	11



Levacapsule

Bottle-opener



Cod.	L cm
472700	14



Copribottiglia conico

Bottle cap



Cod.
4723002



Spremilimone

Lemon slice squeezer



Cod.
4728002



Fermatovaglia

Table-cloth fixer



Cod.	Box
472500	12



Spremilimone

Lemon slice squeezer



Cod.
4729002

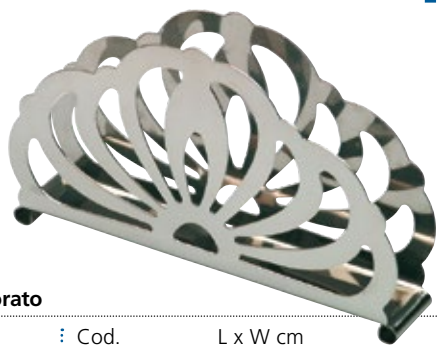

Portatovaglioli traforato

Napkin-holder Cod. L x W cm
 473000 13,5 x 7



Posacenere

Ash-tray Cod. L x W cm
 473500 9 x 9



Portatovaglioli traforato

Napkin-holder Cod. L x W cm
 473100 13,5 x 7



Coppa per gelato e macedonia

Fruit-salad cup Cod. Ø cm
 473600 11



Portatovaglioli con base teak

Napkin stand Cod. L x W cm
 473200 14 x 8



Sottocoppa per gelato

Ice-cream saucer Cod. Ø cm
 474100 12,5



Cuocithé a cucchiaino

Spoon tea infuser Cod. L cm
 473300 15



Sottobicchiere

Coaster Cod. Ø cm
 474209 9
 474210 10



Sottobottiglia

Coaster Cod. Ø cm
 474213 13
 4742132 13



Cod. 4742132



Cod. 4742132

Cuocithé a campana

Bell tea boiler Cod. L cm
 473400





Boston shaker in acciaio

Stainless steel boston shaker	Cod.	Col.	ml
	474690	○	900
	474700	●	900
	474703	●	900
	474711	●	900



Boston shaker in acciaio

Stainless steel boston shaker	Cod.	Col.	ml
	474701	●	900
	474707	●	900
	474790	○	900



Boston shaker in acciaio colorato

Coloured stainless steel boston shaker	Cod.	Col.	ml
	474750	●	900
	474753	●	900
	474754	●	900
	474756	●	900
	474757	●	900
	474762	○	900
	474763	●	900
	474764	●	900



Boston shaker in acciaio

Stainless steel boston shaker	Cod.	ml
	474850	500



Boston shaker in acciaio a due pezzi

2-parts stainless steel boston shaker	Cod.
	474890





Colino per cocktail

Cocktail strainer Cod. L cm
 470900 16



Bicchieri vetro per boston shaker

Glass for boston shaker Cod. ml Box
 474900 474 6

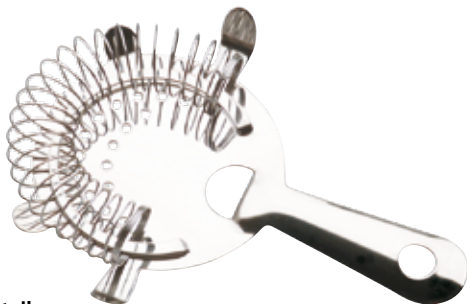

Colino per cocktail

Cocktail strainer Cod.
 475600



Bicchieri vetro per boston shaker temperato

Tempered glass for boston shaker Cod. ml Box
 474901 414 6



Colino per cocktail in acciaio con manico vuoto

Steel cocktail strainer with hollow handle Cod.
 475601



Bicchieri vetro per boston shaker graduato

Scaled glass for boston shaker Cod. ml Box
 474902 474 6



Colino per cocktail in acciaio color grafite

Black steel cocktail strainer Cod.
 475605



Bicchieri vetro "beverage" per boston shaker

"Beverage" glass for boston shaker Cod. ml Box
 474904 414 6



**Japmixing glass
con beccuccio**

Japmixing glass with lip

Cod.	ml
474906	650

**Mixing glass double wall
in acciaio con beccuccio**

 Stainless steel double wall
mixing glass with lip

Cod.	ml
474910	535

**Bicchieri Juice
per cocktail**

Juice cocktail glass

Cod.	ml	Box
474915	421	12

**Bicchieri High Ball
per cocktail**

High Ball cocktail glasses

Cod.	ml	Box
474916	361	12
474920	361	12

**Bicchieri Rocks,
Shooter e Shot Rocks
per cocktail**

 Rocks. Shooter and Shot
Rocks cocktail glasses

Cod.	ml	Box
474917	269	12
474918	137	12
474919	37	12

Shaker a 2 pezzi lucido

2-parts polished shaker

Cod.	ml
475055	550





Shaker a 2 pezzi in acciaio

2-parts steel shaker

Cod. **475060** ml 600



Shaker a 2 pezzi in acciaio ramato

2-parts copper plated shaker

Cod. **475160** ml 600



Shaker a 3 pezzi satinato

2-parts brushed shaker

Cod. **477080** ml 800



Shaker a 3 pezzi in acciaio

3-parts steel shaker

Cod. **475225** ml 250
475250 ml 500
475275 ml 750



Shaker a 3 pezzi lucido

3-parts polished shaker

Cod. **475175** ml 750



Shaker a 2 pezzi in ottone

2-parts brass shaker

Cod. **475440** ml 400



Shaker a 2 pezzi in rame

2-parts copper shaker

Cod. **477260** ml 600



Shaker a 2 pezzi in acciaio color grafite

2-parts steel black shaker

Cod. **477160** ml 600





Jigger in acciaio Japan style

Stainless steel jigger
Japan style

Cod.	ml	Col.
475542	25 x 50	●
475544	25 x 50	●



Jigger Japan style

Jigger Japan style

Cod.	ml	Col.
475546	30 x 50	●
475547	30 x 45	●



Jigger in acciaio Japan style

Stainless steel jigger
Japan style

Cod.	ml
475535	20 x 40
475543	25 x 50
475550	15 x 30
475555	30 x 60
475560	30 x 45



NEW



Jigger in acciaio slim

Stainless steel jigger
slim

Cod.	ml
475570	30 x 45
475575	25 x 50
475580	30 x 60



NEW



Jigger in acciaio

Steel double jigger

Cod.	ozs
475545	3/4 x 1.1/2



Jigger in acciaio

Stainless steel jigger

Cod.	ml	Col.
475590	30 x 60	●
475591	30 x 60	●
475592	30 x 60	●





Jigger in acciaio
Mixing Tin style

Stainless steel jigger
Mixing Tin style

Cod. 475500 ml 75



Jigger in acciaio

Stainless steel jigger

Cod. 475565 ml 75



Jigger in plastica

Plastic jigger

Cod. 475548 ml 20 x 40
475549 ml 10 x 20



Jigger

Double jigger

Cod. 470812 scaled 20-30-50 ozs 1 - 2
470813 1 - 3
470823 2 - 3



pack
Bartending
essentials



Set 8 pezzi Bartending Essentials

Bartending Essential
Pack 8 pcs.

Cod. 665500



pack
Bartending
black edition



Set 5 pezzi Bartending Black Edition

Bartending Black Edition
Pack 5 pcs.

Cod. 665600



- 0533002 TAPPO VERSATORE STEADYSPOUT STEADYSPOUT POURER (2 PZ.)
- 470900 COLINO COCKTAIL COCKTAIL STRAINER
- 474690 BOSTON SHAKER IN ACCIAIO STAINLESS STEEL BOSTON SHAKER
- 475545 JIGGER IN ACCIAIO STEEL DOUBLE JIGGER 3/4 x 1.1/2 OZS
- 475828 CUCCHIAIO MISCELAT. CON PESTELLO MIXING SPOON WITH STUD
- 510200 PESTELLO RIGATO IN POLIPROPILENE POLYPROP. RIBBED PESTLE
- TUMBLER ALTO IN POLICARBONATO POLYCARB. HIGH TUMBLER

- 053212 TAPPO VERSATORE POURER
- 475542 JIGGER IN ACCIAIO STEEL DOUBLE JIGGER 25/50 ML
- 475605 COLINO COCKTAIL COCKTAIL STRAINER
- 475832 CUCCHIAIO MISCEL. CON FORCHETTA MIXING SPOON WITH FORK
- 477160 COCKTAIL SHAKER IN ACCIAIO STEEL COCKTAIL SHAKER 600 ML



Moscow Mule mug bombata in acciaio ramato e martellato

Copper plated hammered Moscow Mule mug Cod. ml
4783002 470



Moscow Mule mug bombata in acciaio dorato e martellato

Golden plated hammered Moscow Mule mug Cod. ml
478302 5000



Moscow Mule mug bombata in acciaio ramato

Copper plated Moscow Mule mug Cod. ml
4783052 470



Mug in acciaio ramato

Copper plated mug Cod. ml
4783152 470



Beer mug in acciaio ramato, effetto anticato

Copper plated beer mug antique Cod. ml
4783252 500



Cod. 4783302
 Cod. 4783352



Beer mug in acciaio ramato, effetto anticato

Copper plated beer mug antique Cod. ml
4783302 500
478335 400
4783352 400



Julep mug in acciaio inox

Stainless steel julep mug Cod. ml
4781482 380





**Mug ananas
in acciaio ramato**

Copper plated
pineapple mug

Cod. 478321 ml 550



**Mug zucca
in acciaio ramato**

St. steel copper plated
gourd mug

Cod. 478351 ml 350



Mug in acciaio

Stainless steel mug

Cod. 478350 ml 700



**Mug zucca
in acciaio ramato**

St. steel copper plated
pumpkin mug

Cod. 478352 ml 650



**Mug pera
in acciaio**

Stainless steel pear mug

Cod.	ml	Col.
478340	425	●
478341	425	●
478342	425	●



**Wine glass in acciaio
color grafite**

Black stainless steel
wine glass

Cod. 4783452 ml 550



**Double wall mug
in acciaio martellato**

St. steel hammered
double wall mug

Cod. 4781002 ml 420



**Double wall mug in acciaio
ramato e martellato**

St. steel copper plated
hammered double wall mug

Cod. 4781012 ml 420





479190

Dash bottle old fashioned

Dash bottle old fashioned	Cod.	ml
	479101	100
	479190	Tappo versatore/Pourer for dash bottle



TAPPO VERSATORE NON INCLUSO
POURER NOT INCLUDED



479190

Dash bottle

Dash bottle	Cod.	ml
	479110	100
	479190	Tappo versatore/Pourer for dash bottle



TAPPO VERSATORE NON INCLUSO
POURER NOT INCLUDED



Vaporizzatore cocktail in vetro "Old fashioned"

Cocktail atomizer "Old fashioned"	Cod.	ml
	479121	100



IMBUTO DI RIEMPIMENTO INCLUSO NELLA CONFEZIONE
FUNNEL INCLUDED IN THE PACKAGE



Vaporizzatore cocktail cromato

Chromed cocktail atomizer	Cod.	ml
	479130	65



IMBUTO DI RIEMPIMENTO INCLUSO NELLA CONFEZIONE
FUNNEL INCLUDED IN THE PACKAGE



Kit 4 vaporizzatori cocktail in vetro 2 cilindrici + 2 quadrati

Pack 4 cocktail atomizers 2 cylindrical + 2 square	Cod.	ml.
	479150	33



IMBUTO DI RIEMPIMENTO INCLUSO NELLA CONFEZIONE
FUNNEL INCLUDED IN THE PACKAGE



Vaporizzatore cocktail dorato

Golden plated cocktail atomizer	Cod.	ml.
	479131	65



IMBUTO DI RIEMPIMENTO INCLUSO NELLA CONFEZIONE
FUNNEL INCLUDED IN THE PACKAGE



Cucchiaino miscelatore in acciaio con tappo rosso

Steel mixing spoon	Cod.	L cm	Box
	475725	25	12
	475728	28	12



Cucchiaino miscelatore in acciaio a goccia

Drop steel mixing spoon	Cod.	L cm	Box
	475800	25	6
	475805	30	6
	475810	40	6
	475815	50	6



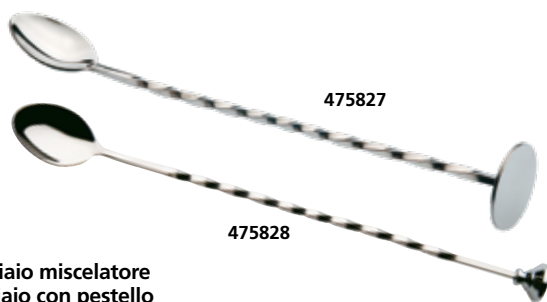

Cucchiaino miscelatore in acciaio con pestello

Steel mixing spoon with stud	Cod.	L cm	Box
	475827	27	12
	475828	28	12



Cucchiaino miscelatore in acciaio con forchetta

Steel mixing spoon with fork	Cod.	L cm	Col.	Box
	475830	30	●	6
	475831	30	●	6
	475832	30	●	6

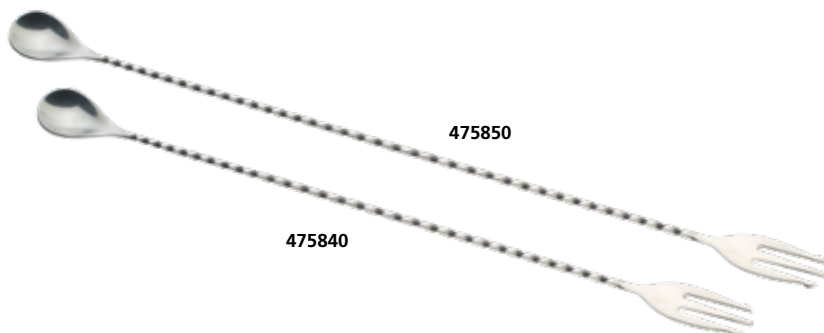

Cucchiaino miscelatore in acciaio con forchetta

Steel mixing spoon with fork	Cod.	L cm	Box
	475840	40	6
	475850	50	6



Cucchiaino miscelatore in acciaio coppa ovale

Oval cup steel mixing spoon	Cod.	L cm	Box
	475930	30	12



Sifone soda per cocktail

Soda cocktail siphon	Cod.	Lt
	476202	1
	476250	Ricarica/Refill (10 pz/pcs)
	476255	Cappuccio copertura/Cover hood



Spremilimone nero

Lemon squeezer black	Cod.
	476402



Coltello per agrumi

Citrus fruit knife	Cod.	L cm	Box
	476600	21	12



Spremilimone/spremilime nero e rosso

Lemon/lime squeezer black and red	Cod.
	476412





Apribottiglie piatto in acciaio gommato

Flat steel bottle-opener with vinyl coated

Cod.	L cm	Col.	Box
476700	18	●	12
476703	18	●	12
476704	18	●	12



Apribottiglie da muro in acciaio

Steel wall-mounted bottle-opener

Cod.	Box
477400	12



Apribottiglie piatto in acciaio

Flat steel bottle-opener

Cod.	L cm	Box
476800	18	12



Apribottiglie da muro

Wall-mounted bottle-opener

Cod.
477500



Apribottiglie professionale in acciaio satinato

Professional satin-finish steel bottle-opener

Cod.
476900



Spirale di ricambio per apribottiglie muro e tavolo

Spare screw for table/wall corkscrews

Cod.	Box
477550	12



Pinza apribottiglie in acciaio

Steel champagne opener

Cod.
477300





Sessola in acciaio

Steel all purpose scoop Cod. L cm Box
 477900 24 12



Secchiello ghiaccio in acciaio

Steel ice bucket Cod. Ø cm H cm
 478014 14 16



Secchiello vino in acciaio

Steel wine bucket Cod. Ø cm H cm
 478421 21 21



Secchiello vino in acciaio

Steel wine bucket Cod. Ø cm H cm
 478624 24 26

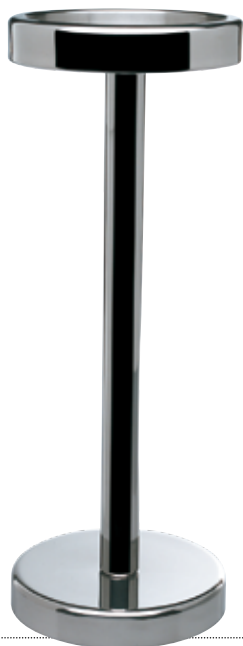

Colonna per secchiello in acciaio

Stand for steel bucket Cod. Ø cm H cm
 478525 25 65



PER FOR
478421

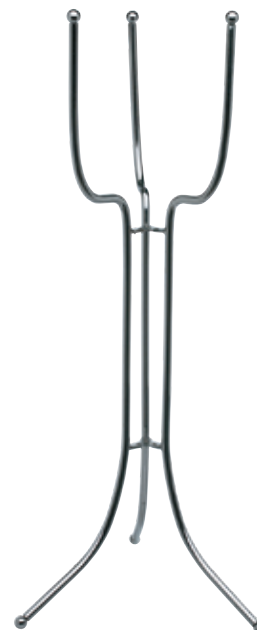

Colonna a filo in acciaio per secchiello vino

Steel wire bucket stand Cod. Ø cm H cm
 478760 24 60



PER FOR
478624



Spumantiera in acciaio

Steel champagne bowl Cod. Ø cm
 479400 40





Portatovaglioli in acciaio

Napkin holder	Cod.	H cm	Box
	479600	18	6
	479601	10	6



Speed racks in acciaio

Steel speed racks	Cod.	L cm
	479900	56
	479901	82
	479902	107



Portacondimenti in acciaio con 3 contenitori

Steel cruet with 3 containers	Cod.	L x W cm	H cm
	479803	45 x 15	9



Sifone termico per panna montata

Thermos syphon for whipped cream	Cod.	Lt
	480005	0,5



Portacondimenti in acciaio con 4 contenitori

Steel cruet with 4 containers	Cod.	L x W cm	H cm
	479804	30 x 14	9



Portacondimenti in acciaio con 6 contenitori

Steel cruet with 6 containers	Cod.	L x W cm	H cm
	479806	45 x 15	9



Sifone per panna montata

Whipped cream syphon	Cod.	Lt
	480105	0,5
	480110	1



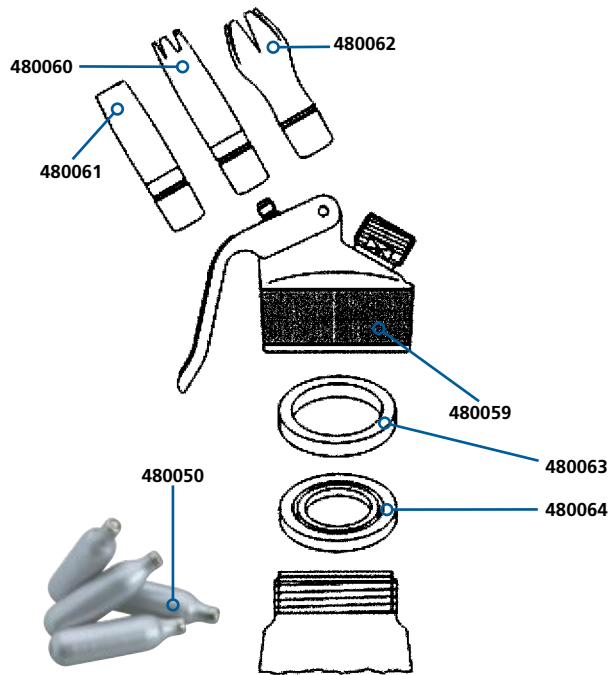

Ricambi per sifone panna montata

Spare parts for whipped cream syphon

- | | | |
|------|---------------|---|
| Cod. | 480050 | Ricarica/Refill (10 pz/pcs) |
| | 480059 | Testata completa in metallo/Head complete metal |
| | 480060 | Decoratore di ricambio rosso/Round shape nozzle red |
| | 480061 | Decoratore di ricambio piatto/Plain shape nozzle |
| | 480062 | Decoratore di ricambio tulipano/Tulip shape nozzle |
| | 480063 | Guarnizione per testata rossa/Head gasket red |
| | 480064 | Guarnizione per testata grigia/Head gasket grey |



Portacenere in acciaio rotondo

Round steel ashtray

Cod.	481113	Ø cm	13	Box	12
------	---------------	------	----	-----	----



Raccoglibriciole in alluminio

Aluminium crumb collector

Cod.	490108	Box	24
------	---------------	-----	----



Barra ordinazioni in alluminio

Aluminium order rack

Cod.	490000	L cm	30
	490001		45
	490002		61
	490003		91
	490004		122



Posacenere in alluminio

Aluminium ashtray

Cod.	490408	Ø cm	10	Col.	○
------	---------------	------	----	------	---





Versus completo da 0,5 lt

Complete versus 0.5 lt	Cod.	Col.	cl	Box
	500000		50	12



Versus completo da 1 lt

Complete versus 1 lt	Cod.	Col.	cl	Box
	500200		100	12
	500201		100	12
	500203		100	12
	500204		100	12
	500206		100	12



Versus riserva da 0,5 lt
Colori assortiti

Spare versus 0.5 lt (various colours)	Cod.	Col.	cl	Box
	500100		50	12



Versus riserva da 1 lt
Colori assortiti

Spare versus 1 lt (various colours)	Cod.	Col.	cl	Box
	500300		100	12



versus

Design by Michele Capuani

Una gamma completa di versatori, risultato di un progetto studiato fin nei minimi particolari, in grado di offrire ai professionisti del settore Bar prestazioni ineguagliabili. Materiali di prim'ordine, caratteristiche tecniche all'avanguardia, forme progettate ergonomicamente, dettagli costruttivi analizzati fin nei minimi particolari, tutto è stato studiato per garantire non solo prestazioni "al top" in ogni situazione, ma anche per offrire il massimo in termini di comodità, praticità, facilità d'uso, igienicità.

A complete range of pourers, the result of a detailed project, capable of offering Bar professionals unmatched performance. Top grade materials, advanced technology, ergonomic design, construction details that have been carefully studied right down to the smallest details: all aimed at guaranteeing not just "top" performance in all situations, but also max comfort, practicality, ease of use and hygiene.



Chiodibeccuccio a tenuta per garantire la massima igienicità nell'utilizzo.

Spout seal to guarantee max hygiene during use.

Beccuccio versatore in colori assortiti, studiato per offrire un flusso del liquido costante ed omogeneo. Il suo ancoraggio al collo di versus avviene attraverso un giro completo di filettatura per una tenuta ottimale in ogni condizione d'uso.

Pouring spout in various colours, designed to get a constant, even flow. Fixed to the neck of the versus via 360° threading for excellent tightness in all conditions.

Il collo è stato disegnato secondo principi ergonomici per consentire una perfetta impugnatura e rendere l'operazione di versatura pratica e veloce in tutte le condizioni di utilizzo. La sua particolare filettatura (a doppio giro) garantisce una tenuta totale, rendendolo nel contempo universale, può essere infatti montato non solo su tutte le riserve versus ma anche su quelle delle altre marche più diffuse.

The ergonomic design of the neck makes for a perfect grip and practical, fast operation in all conditions. The special threading (double turn) guarantees perfect tightness and an universal fitting not only to the versus juice containers but to other leading brands, too.

La riserva, disponibile in varie capacità, con la sua comoda scala graduata consente l'immediata visione della quantità di prodotto presente all'interno.

The juice containers, available in various sizes, have a useful graduated scale and you can immediately see how much liquid they contain.

La base zigrinata della riserva permette il perfetto ancoraggio del suo coperchio quando questo viene rimosso per inserire il collo.

The knurled base of the juice containers allows a perfect fitting of its cover once removed to assemble the neck.



Versus completo da 2 lt

Complete versus 2 lt	Cod.	Col.	cl	Box
	500400		200	12
	500401		200	12
	500403		200	12
	500404		200	12
	500406		200	12



**Versus riserva da 2 l.
Colori assortiti**

Spare versus 2 lt (various colours)	Cod.	Col.	cl	Box
	500500		200	12



**Versus con
beccuccio versatore
Piazza/Planet One**

Versus with Piazza/Planet One pouring spout	Cod.	Col.	cl	Box
	500800		100	12
	500801		100	12
	500803		100	12
	500804		100	12
	500806		100	12



**Speed bottle
completo da 1 litro**

Speed bottle 1 litre	Cod.	Col.	cl	Box
	500900		100	12
	500901		100	12
	500903		100	12
	500904		100	12
	500906		100	12

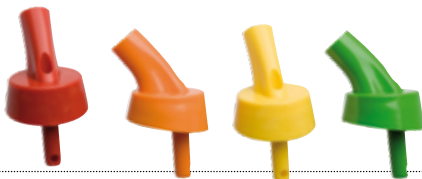

**Beccuccio versatore
Piazza/Planet One**

Piazza/Planet One pouring spout	Cod.	Col.	Box
	500811		48
	500813		48
	500814		48
	500816		48

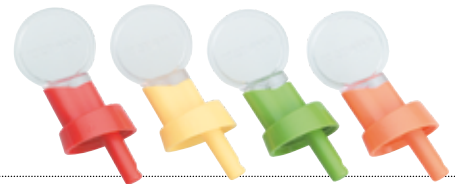

**Beccuccio versatore
"Versus"**

"Versus" pouring spout	Cod.	Col.	Box
	50100112		4
	50100312		4
	50100412		4
	50100612		4



**Versus con beccuccio
versatore Piazza/Planet One**

Versus with Piazza/Planet One pouring spout	Cod.	cl	Box
	500890	100	12



**Coperchio chiusura
"Versus"**

"Versus" lid	Cod.	Col.	Box
	5011016		8
	5011036		8
	5011046		8
	5011066		8



**Supporto per bottiglia
finitura cromata 0,7 - 1 litro**

Chrome bottle stand
0.7 - 1 litre

Cod.	501500
------	---------------



**Supporto in plastica
per bottiglia 0,7 - 1 litro**

Plastic bottle stand
0.7 - 1 litre

Cod.	501600
------	---------------



Porzionatore in plastica nero

Black plastic measure	Cod.		cl
	501700		2
	501705		4
	501706		5



**Portacondimenti
plastica con 3 contenitori (L)**

Black plastic cruet
with 3 containers (L)

Cod.		L x W cm	H cm
502000		49 x 15	9



**Portacondimenti
plastica con 4 contenitori (M)**

Black plastic cruet
with 4 containers (M)

Cod.		L x W cm	H cm
502100		49 x 15	9



**Portacondimenti
plastica con 6 contenitori (S)**

Black plastic cruet
with 6 containers (S)

Cod.		L x W cm	H cm
502300		49 x 15	9



Contenitore sostitutivo in plastica

Spare plastic container	Cod.		L x W cm	H cm	Box
	502400		7 x 14 (S)	7	12
	502401		14 x 14 (L)	7	12
	502402		11 x 14 (M)	7	12





Portaoggetti da bar in plastica

Plastic bar organizer	Cod.	L x W cm	H cm
	502500	24 x 14	10

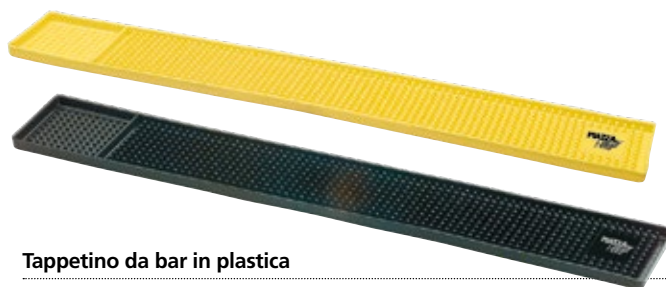

Tappetino da bar in plastica

Plastic bar mat	Cod.	L x W cm	Col.
	502900	7,5 x 58,5	●
	502903	8,5 x 60	●



Bordatore di bicchieri nero a 2 unità in plastica

2-tier black plastic glass rimmer	Cod.
	502600



Tappetino da servizio nero in plastica

Black plastic bar mat	Cod.	L x W cm
	503000	30,5 x 46



Bordatore di bicchieri nero a 3 unità in plastica

3-tier black plastic glass rimmer	Cod.
	502700



Tagliere in polietilene nero

Black polyethylene cutting board	Cod.	L x W cm	H cm
	503200	30 x 50	2



Spugna sostitutiva per bordatori

Spare sponge for glass rimmer	Cod.
	502800



Pestello in legno di caucciù

Pestle	Cod.	L cm
	503300	19
	503301	25

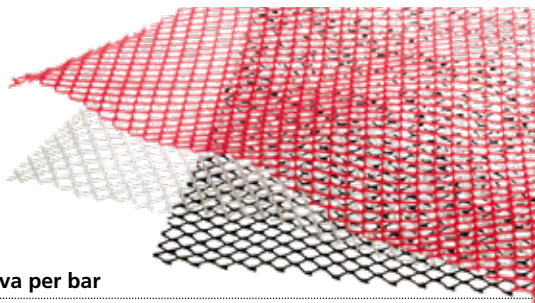

Rete protettiva per bar

Protection mesh for bar	Cod.	L x W cm	Col.
	503400	61 x 610	●
	503401	61 x 610	●
	503402	61 x 610	○

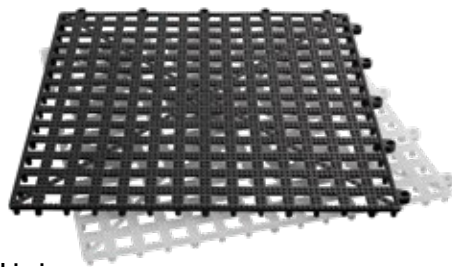

Tappetino scolabicchieri

Dri-dek interlocking glass mat	Cod.	L x W cm	Col.
	503410	33 x 33	●
	503411	33 x 33	○

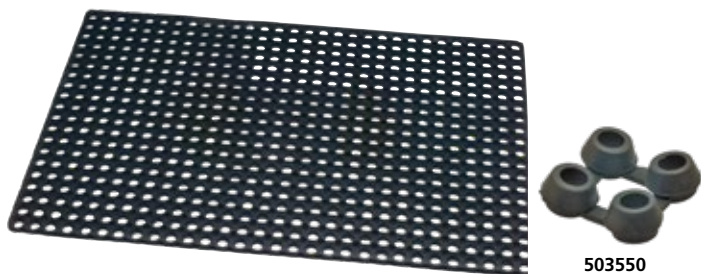

503550

Tappeto antiscivolo

Non slip matting	Cod.	L x W cm
	503500	91 x 91
	503501	80 x 120
	503502	100 x 150
	503550	Ganci fissaggio/Carpet hooks (25 pz/pcs)



503700

503701

Flair bottle professionale

Professional flair bottle	Cod.	cl
	503700	75
	503701	75



503703

503705

Flair bottle

Flair bottle	Cod.	cl	Col.
	503703	75	○
	503705	75	○



Flair bottle

Flair bottle	Cod.	cl	Col.
	503710	75	○
	503712	75	○
	503713	75	●
	503716	75	●





Rompighiaccio manuale blu in plastica

Blue plastic manual ice-breaker Cod. **503807**



CON VENTOSE STABILIZZANTI WITH STABILISING SUCKERS



Rompighiaccio a 6 punte

6-point ice-breaker Cod. **504000**



Posacenere rotondo in plastica

Round plastic ashtray	Cod.	Ø cm	Col.	Box
	504100	10	●	6
	504101	10	●	6



Rompighiaccio manuale in plastica finitura cromo

Chrome-finished plastic manual ice-breaker Cod. **503900**



Posacenere rotondo in plastica

Round plastic ashtray	Cod.	Ø cm	Col.	Box
	504200	14	●	6
	504201	14	●	6



Vaso posacenere in resina con sabbia

External ashtray in resin with sand	Cod.	Ø cm	H cm	Col.
	504300	36	55	●
	504301	36	55	●
	504305	Griglia di ricambio/Spare grid		

Icon of a cube and glass Cod. 504305



LA SABBIA FAVORISCE LO SPEGNIMENTO DELLE SIGARETTE SENZA AVERE CONTATTO CON SUPERFICI POCO IGIENICHE
THE SAND HELPS TO EXTINGUISH CIGARETTES, AVOIDING CONTACT WITH UNHYGIENIC SURFACES



GRAZIE ALLE COMODE MANIGLIETTE SI ESTRAE IL SETACCIO DALLA SABBIA SENZA FATICA
THE SIEVE IS EASILY EXTRACTED FROM THE SAND WITH THE HANDLES



DOPO LO SVUOTAMENTO DAI MOZZICONI IL SETACCIO PUÒ ESSERE RIPOSIZIONATO
AFTER EMPTYING, THE SIEVE IS REPLACED



CON UN LEGGERO MOVIMENTO DI PRESSIONE E ROTAZIONE IL SETACCIO SCOMPARE NELLA SABBIA
WITH LIGHT PRESSURE AND ROTATION THE SIEVE DISAPPEARS INTO THE SAND



Dispenser in polietilene

Polyethylene dispenser	Cod.	ml	ozs	Col.	Box
	5045016	236	8	●	6
	5045026	236	8	○	6
	5045036	236	8	●	6
	5046016	354	12	●	6
	5046026	354	12	○	6
	5046036	354	12	●	6
	5047016	708	24	●	6
	5047026	708	24	○	6
	5047036	708	24	●	6



Bicchieri policarbonato

Polycarbonate glass	Cod.	ml	ozs	Col.	Box
	504901	236	8	●	72
	504902	236	8	○	72



Bicchieri policarbonato

Polycarbonate glass	Cod.	ml	ozs	Box
	505002	354	12	72



Bicchieri in plastica zigrinata trasparente

Clear knurled plastic glass	Cod.	ml	ozs	Box
	505300	148	5	72
	505301	237	8	72
	505302	296	10	72
	505303	355	12	72



Bicchieri policarbonato "Old Fashion"

"Old Fashion" polycarbonate glass	Cod.	ml	Box
	505402	266	72



Calice policarbonato trasparente

Clear polycarbonate goblet	Cod.	ml	Box
	505500	414	24



Flute policarbonato trasparente

Clear polycarbonate flute	Cod.	ml	Box
	505501	170	24



Calice per "Margarita" in policarbonato

Clear "Margarita" polycarbonate cocktail glass	Cod.	ml	Box
	505502	274	24





Bicchieri in plastica trasparente

Clear plastic glass	Cod.	ml	Box
	505700	360	50
	505701	400	50
	505702	290	80
	505705	40	60
	505750	400	50



Bicchieri in polipropilene ghiaccio

Iced polypropylene glass	Cod.	ml	Box
	505800	360	50
	505801	400	50



Bicchieri in plastica

Plastic glass	Cod.	ml	Box
	505907	360	50



Caraffa in policarbonato trasparente con coperchio

Clear polycarbonate carafe with top	Cod.	Lt	Box
	506100	1,7	6



Caraffa in policarbonato trasparente

Clear polycarbonate carafe	Cod.	Lt	Box
	506200	0,95	6
	506201	1,4	6
	506202	1,8	6



Caraffa in policarbonato trasparente

Clear polycarbonate carafe	Cod.	Lt	Box
	506300	1,4	6
	506301	1,8	6



Caraffa in plastica

Plastic carafe	Cod.	Lt	Col.	Box
	506501	1,8	●	12
	506502	1,8	○	12
	506503	1,8	●	12





Sessola in policarbonato

Polycarbonate ice scoop	Cod.	ml	Box
	506800	180	6
	506801	360	6
	506802	720	6



NEW

Sessola in polipropilene

Polypropylene ice scoop	Cod.	ml	Box
	506811	360	6

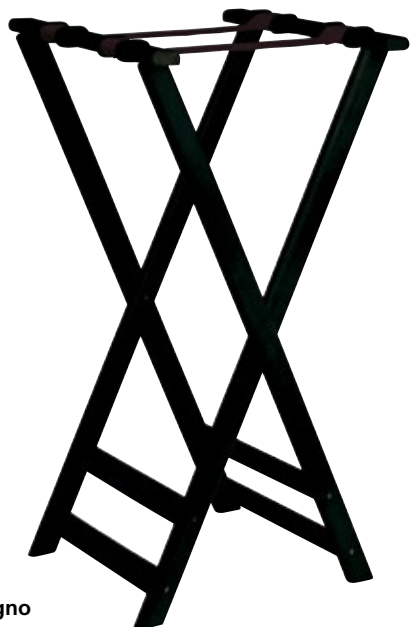

Poggiavassoio in legno color nero

Black wood tray rest	Cod.	L x W cm	H cm
	506900	43 x 43	83



Portazucchero trasparente in plastica

Clear plastic sugar bowl	Cod.	Box
	5074022	6



Portazucchero in plastica

Plastic sugar bowl	Cod.	Col.	Box
	5075002	●	6
	5075012	●	6
	5075022	○	6
	5075032	●	6
	5075042	●	6

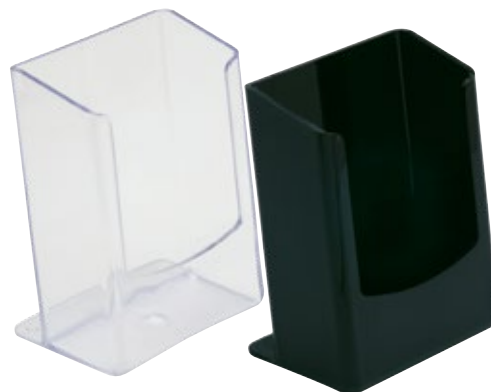

Portatovaglioli in plastica

Plastic serviette holder	Cod.	Col.	Box
	5079002	●	6
	5079022	○	6





Cestino in polipropilene ovale

Oval polypropylene basket	Cod.	L x W cm	Col.	Box
	5070016	24 x 15	●	6
	5070036	24 x 15	●	6
	5070046	24 x 15	●	6
	5070056	24 x 15	●	6
	5070066	24 x 15	●	6

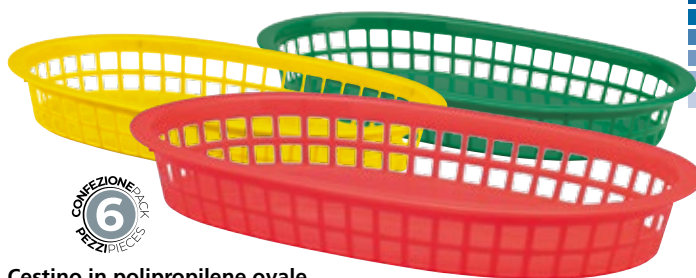

Cestino in polipropilene ovale

Oval polypropylene basket	Cod.	L x W cm	Col.	Box
	5071016	28 x 18	●	6
	5071036	28 x 18	●	6
	5071046	28 x 18	●	6



Cestino in polipropilene color vimini naturale rotondo

Round polypropylene natural wicker basket	Cod.	Ø cm	H cm
	508518	18	5
	508521	21	6



NON ADATTO ALLA LAVASTOVIGLIE
NOT DISHWASHER SAFE



Cestino in polipropilene color vimini naturale rettangolare

Rectangular polypropylene natural wicker basket	Cod.	L x W cm	H cm
	508623	23 x 15	6



NON ADATTO ALLA LAVASTOVIGLIE
NOT DISHWASHER SAFE



Cestino in polipropilene color vimini naturale ovale

Oval polypropylene natural wicker basket	Cod.	L x W cm	H cm
	508718	18 x 13	5
	508723	23 x 16	6
	508725	25 x 17	8



NON ADATTO ALLA LAVASTOVIGLIE
NOT DISHWASHER SAFE



Cestino in polipropilene color vimini naturale oblungo

Oblong polypropylene natural wicker basket	Cod.	L x W cm	H cm
	508823	23 x 9	5
	508828	28 x 15	8
	508833	33 x 13	8



NON ADATTO ALLA LAVASTOVIGLIE
NOT DISHWASHER SAFE



Cestino in polipropilene intrecciato marrone rotondo

Round brown woven polypropylene basket	Cod.	Ø cm	H cm
	509529	29	8



NON ADATTO ALLA LAVASTOVIGLIE
NOT DISHWASHER SAFE



Cestino in polipropilene intrecciato marrone ovale

Oval brown woven polypropylene basket	Cod.	L x W cm	H cm
	509627	27,5 x 20	7



NON ADATTO ALLA LAVASTOVIGLIE
NOT DISHWASHER SAFE



Pestello in polipropilene liscio

Smooth polypropylene pestle	Cod.	L cm	Col.	Box
	510000	21	●	6
	510002	21	○	6

Cod. 510000



Pestello in polipropilene rigato

Ribbed polypropylene pestle	Cod.	L cm	Col.	Box
	510200	21,5	●	6
	510202	21,5	○	6

Cod. 510200



NEW

Pestello in polipropilene nero

Black polypropylene pestle	Cod.	L cm
	510300	21,5



Pestello in legno di caucciù

Pestle	Cod.	L cm
	503300	19
	503301	25





CONFEZIONE PACK
1000
PEZZI/PIECES

7 mm

Cannucce diritte

Straight straws

Cod.	L cm	Col.	Box
515002	13,5	○	10
515004	13,5	●	10
515020	13,5	●●●●	10
515026	13,5	●	10
515110	21	○	10
515201	16	●	10
515206	16	●	10



CONFEZIONE PACK
1000
PEZZI/PIECES

6mm

Cannucce diritte nere

Black straight straws

Cod.	L cm	Box
515300	13	20



CONFEZIONE PACK
4
PEZZI/PIECES

6mm

Cannuccia diritta in acciaio inox nero

Black straight stainless steel straw

Cod.	L cm
517000	13



CON SCOVOLINO WITH STRAW CLEANER



CONFEZIONE PACK
4
PEZZI/PIECES

6mm

Cannuccia diritta in acciaio inox

Straight stainless steel straw

Cod.	L cm
517021	13



CON SCOVOLINO WITH STRAW CLEANER

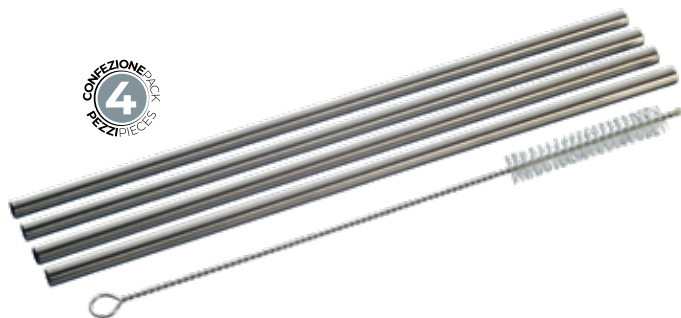

CONFEZIONE PACK
4
PEZZI/PIECES

6mm

Cannuccia diritta in acciaio inox

Straight stainless steel straw

Cod.	L cm
517121	21,5



CON SCOVOLINO WITH STRAW CLEANER

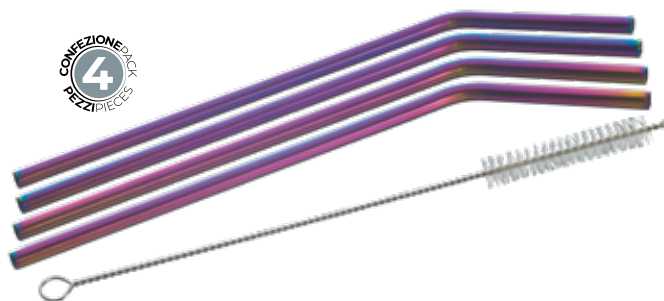

CONFEZIONE PACK
4
PEZZI/PIECES

6mm

Cannuccia piegata in acciaio inox colorato

Bended coloured stainless steel straw

Cod.	L cm
517420	21,5



CON SCOVOLINO WITH STRAW CLEANER

RICAMBI SPARE PARTS

COD.	DESCRIZIONE DESCRIPTION	ADATTO A SUITABLE FOR
557000	Bicchiere completo inox 1 Lt Complete stainless steel beaker 1 Lt	550000
557001	Coperchio blender 1 Lt Lid for blender 1 Lt	550000
557002	Blocco lame per blender 1 Lt.- 1,5 Lt.- 3 Lt. Chopping blade check for blender 1 Lt - 1.5 Lt - 3 Lt	550000-550100-550101-550200-550201-550302
557003	Guarnizione bicchiere blender 1 Lt.- 1,5 Lt.- 3 Lt. Beaker seal for blender 1 Lt - 1.5 Lt - 3 Lt	550000-550100-550101-550200-550201-550302
557005	Giunto femmina per blender 1 Lt.- 1,5 Lt.- 3 Lt. Female fitting for blender 1 Lt - 1.5 Lt - 3 Lt	550000-550100-550101-550200-550201-550302
557006	Base per bicchiere blender 1 Lt.- 1,5 Lt.- 3 Lt. Beaker base for blender 1 Lt - 1.5 Lt - 3 Lt	550000-550100-550101-550200-550201-550302
557007	Motore per blender 600W-220V Blender motor 600W-220V	550000-550100-550200
557008	Motore blender 1200W-220V Blender motor 1200W-220V	550101-550201-550302
557009	Giunto maschio in acciaio per blender 1 - 1,5 - 3 Lt. Stainless steel male fitting for blender 1 - 1.5 - 3 Lt	550000-550100-550101-550200-550201-550302
557010	Supporto giunto in alluminio Support joint aluminium	550100-550200-551100
557011	Calotta frullatore lucida Polished cap blender	551100-551200
557012	Microinterruttore a leva Microswitch lever	550602-551100-551200
557100	Bicchiere completo policarbonato 1,5 Lt 100% polycarbonate beaker 1.5 Lt	550100-550101
557101	Coperchio blender 1,5 Lt Lid for blender 1.5 Lt	550100-550101-550200-550201-550700
557104	Tappo in policarbonato per coperchio blender 1,5 Lt Polycarbonate lid for blender 1.5 Lt	550100-550101-550200-550201-550700
557105	Calamita chiusura coperchio blender/rompighiaccio Magnet seal for blender and ice crusher cover	550000-550100-550101-550200 550201-550302-550700
557300	Bicchiere completo inox 3 Lt 100% stainless steel beaker 3 Lt	550302
557301	Coperchio blender 3 Lt Lid for blender 3 Lt	550302
557500	Bicchiere inox mixer Stainless steel mixer beaker	550500-550501
557501	Interruttore accensione mixer Mixer On/Off switch	550500-550501
557503	Motore mixer 220V Mixer motor 220V	550500-550501
557505	Bicchiere mixer in policarbonato Polycarbonate mixer beaker	550500-550501
557506	Bicchiere blender in policarbonato 1,5 Lt Polycarbonate blender beaker 1.5 Lt	550100-550101
557600	Setaccio spremiagrumi Citrus fruit squeezer filter	550601
557602	Ogiva piccola spremiagrumi Small centre for citrus fruit squeezer	550601
557603	Ogiva grande spremiagrumi Big centre for citrus fruit squeezer	550601
557604	Motore spremiagrumi elettrico 220V Electrical citrus fruit squeezer motor 220V	550601
557605	Motore spremiagrumi elettrico 220V Electrical citrus fruit squeezer motor 220V	550602
557701	Scheda filtraggio rompighiaccio Ice-breaker filtering board	550700
557702	Motore rompighiaccio verticale 220V Vertical ice-breaker motor 220V	550700
557703	Vaschetta con griglia rompighiaccio a leva Tray with grille for lever-operated ice-crusher	550701
557704	Motore rompighiaccio a leva 220V Lever-operated ice-crusher motor 220V	550701
557705	Paraolio 15.24.7 Tc per Motore V90 O-Ring Oil	550701
557706	V Ring Nbr Va 14 per Motore V90 V-Ring	550701
557800	Trafila spaghetti Spaghetti maker plate	550800
557801	Trafila tagliatelle Tagliatelle maker plate	550800
557802	Trafila asparagi Asparagus maker plate	550800
557803	Trafila lasagne Lasagne maker plate	550800
557900	Ogiva completa per spremiagrumi Centre for citrus fruit squeezer	550601-550602
558000	Splash cover per spremiagrumi Splash cover for citrus fruit squeezer	550601



Frullatore da bar 1 CV

1 HP commercial blender	Cod.	d
	5610-BB300E	140
	5610-BB320E	140
	5610-BB340E	140



- **Potente motore da 1 CV a 2 velocità con funzione Impulso**
1 HP commercial motor, 2-speed with PULSE function
- **Contenitore da 1,4 litri in copoliestere privo di BPA, lama in acciaio inox**
1.4 liter BPA-free copolyester container with industrial stainless steel blade
- **La base removibile gommata del bicchiere riduce il rumore e facilita la pulizia**
Removable rubberized jar pad dampens sound and makes cleanup easy
- **Tre Margarita da 475 ml in 12 secondi o anche meno**
Three 475 ml. (16 oz.) Margaritas in 12 seconds or less
- **Ideale per preparare da 25 a 50 drinks al giorno**
Recommended for 25-50 drinks per day
- **230 VCA, 750W**



BB340E



BB300E

BB320E



BB300E
COMMUTATORI
HI/LO/OFF (ALTO/
BASSO/STOP) E
PULSE (IMPULSO)
HI/LO/OFF AND
PULSE TOGGLE
SWITCHES



BB320E
TASTIERA
ELETTRONICA
ELECTRONIC
KEYPAD



BB340E
TASTIERA
ELETTRONICA
CON TIMER
DA 99 SECONDI
ELECTRONIC KEYPAD
WITH 99-SECOND
COUNTDOWN TIMER

Xtreme - Frullatore ad alta potenza 3,5 CV

Xtreme - 3.5 HP blender	Cod.	d
	5615-MX1000XTXEE	200
	5615-MX1050XTXEE	200
	5615-MX1100XTXEE	200
	5615-MX1200XTXEE	200
	5615-MX1300XTXEE	200
	5615-MX1500XTXEE	200



- **Motore da 3,5 CV di picco per carichi di lavoro intensi**
Heavy-duty 3½ peak HP motor
- **Velocità pura del motore 32.000 giri/min, 1500 watt**
32,000 RPM bare motor speed, 1500 watts
- **Base del bicchiere monopezzo removibile lavabile in lavastoviglie**
One-piece dishwasher-safe removable jar pad
- **Contenitore da 2 litri in copoliestere privo di BPA**
2 L BPA-free copolyester container
- **Disponibili contenitori in copoliestere privo di BPA da 1,4 litri e in acciaio da 1,4 e 2 litri**
1.4 L BPA-free copolyester container and 1.4 and 2 L stainless steel containers available
- **Disponibilità di involucro antirumore**
(incluso nel modello MX1500)
Optional sound enclosure (included for MX1500)
- **230 VCA, 50 Hz, 6,5 amp**
- **Disponibili anche nella versione 60 Hz**
Also available in 60 Hz



MX1000XTXEE MX1050XTXEE MX1100XTXEE MX1200XTXEE



MX1300XTXEE
INVOLUCRO ANTIRUMORE
NON INCLUSO
SOUND ENCLOSURE
NOT INCLUDED
MX1500XTXEE



MX1000XTXEE
INTERRUTTORI A PALETTA
CON HI (ALTO), LO (BASSO),
E PULSE (IMPULSO)
PADDLE SWITCHES WITH
HIGH, LOW AND PULSE



MX1050XTXEE
TASTIERA ELETTRONICA
CON HI (ALTO), LO (BASSO)
E PULSE (IMPULSO)
ELECTRONIC KEYPAD
WITH HIGH, LOW
AND PULSE FUNCTIONS



MX1100XTXEE
TASTIERA ELETTRONICA
CON HI (ALTO), LO (BASSO),
PULSE (IMPULSO)
E TIMER DA 30 SECONDI
ELECTRONIC KEYPAD WITH
HIGH, LOW, PULSE
FUNCTIONS AND 30-SECOND
TIMER



MX1200XTXEE
MANOPOLA VARIATORE
DI VELOCITÀ E PULSE
(IMPULSO) CON
INTERRUTTORE A PALETTA
VARIABLE SPEED DIAL
CONTROL AND PULSE
PADDLE SWITCH



MX1300XTXEE
MX1500XTXEE
TASTIERA ELETTRONICA
PROGRAMMABILE, LCD
DISPLAY E COMANDO
PULSE PROGRAMMABLE
ELECTRONIC KEYPAD, LCD
DISPLAY AND PULSE





TBB175E

Frullatore da bar Torq 2.0 - 1,4 L

Blender Torq 2.0 - 1.4 L	Cod.	cl
	5610-TBB145E	140
	5610-TBB160E	140
	5610-TBB175E	140



• **Motore da 2 CV, a 2 velocità ad alte prestazioni**

High-performance 2HP motor, 2 speeds

• **Tre Margarita da 475 ml in 8 secondi o anche meno**

Three 475 ml. (16 oz.) Margaritas in 8 seconds or less

• **Contenitore da 1,4 litri in copoliestere privo di BPA, impilabile**

1.4 L BPA-free unbreakable copolyester container

• **Coperchio removibile in gomma alimentare, con foro per aggiungere ingredienti**

Vinyl lid with removable center cap to feed ingredients while blending

• **Resistente giunto di trasmissione in acciaio inossidabile sostituibile**

Heavy-duty stainless steel replaceable drive and jar couplings

• **230 VCA, 60 Hz, 13 amp**



TBB145E

TBB160E



TBB145E
COMMUTATORI HI/LO/OFF (ALTO/BASSO/STOP) E PULSE (IMPULSO)
HI/LO/OFF AND PULSE TOGGLE SWITCHES



TBB160E
TASTIERA ELETTRONICA CON TIMER DA 60 SECONDI
ELECTRONIC KEYPAD WITH 60-SECOND COUNTDOWN TIMER



TBB175E
MANOPOLA VARIATORE DI VELOCITÀ 1000 - 17000 GIRI/MIN
VARIABLE SPEED CONTROL DIAL 1000 - 17000 RPM



Involucro antirumore

Sound enclosure	Cod.	Per/For
	5615-SE500	1,4 L
	5615-SE1000	2 L



ADATTI A TUTTI I FRULLATORI DELLA SERIE MX
FOR ALL BLENDERS IN MX SERIES

Frullatore da 4 Litri

4 liter food blender	Cod.	cl
	5610-CB15VE	400



• **Motore da 3,75 CV per carichi di lavoro intensi**

Heavy-duty 3¾ HP motor

• **I comandi meccanici aumentano la versatilità con 3 velocità e PULSE (Impulso)**

Mechanical controls add versatility with 3 speeds and PULSE

• **Contenitore in acciaio inossidabile con due maniglie e coperchio gommato**

Stainless steel container with two handles and rubberized lid

• **Nuova base del bicchiere monopezzo lavabile in lavastoviglie per una facile pulizia**

New dishwasher-safe one-piece jar pad for easy cleaning

• **Comandi velocità variabile**

Variable speed controls

• **230 VCA, 50 Hz**

• **Approvato CE**

CE approved



Blender immersione cordless

Cordless immersion blender	Cod.	L cm*
	5600-WSB38XE	18



* Lunghezza albero / Shaft length

- **Motore DC senza spazzole**
Brushless DC motor
- **Batteria da 10,8 volt agli ioni di litio**
10.8-volt lithium-ion battery pack for extended runtime
- **Velocità variabile da 5.000 a 13.000 giri/min**
Variable speed from 5,000 to 13,000 RPM
- **Albero da 18 cm rimovibile e lavabile in lavastoviglie**
18 cm removable, dishwasher safe, blending shaft
- **Lama in acciaio inossidabile**
Stainless steel blade
- **12 litri di capacità**
12 L mixing capacity
- **Stazione di ricarica della batteria con circuito di ricarica rapida di 1,5 ore**
Battery charging/docking station with 1.5-hour, quick-charging circuit
- **Indicatori luminosi a LED per velocità e stato di carica della batteria**
LED indicator lights for speeds and battery charge status
- **Design ergonomico**
Ergonomic housing design
- **Borsa di stoccaggio/trasporto inclusa**
Storage/transport bag included
- **Approvato CE, RoHS**
CE, RoHS approved

**Blender immersione compatto**

Compact immersion blender	Cod.	L cm*
	5600-WSB33XE	17,8



* Lunghezza albero / Shaft length

- **Motore ad alta efficienza a 2 velocità**
2-speed high-efficiency motor
- **Albero da 17,75 cm fisso**
17.75 cm fixe shaft
- **Leggero e compatto**
Lightweight and compact
- **Lama polivalente in acciaio inossidabile**
All-purpose stainless steel blade
- **11,5 litri di capacità**
11.5-liter capacity
- **230 volt, 50 Hz, 0,4 amp**
- **Approvato CE, RoHS**
CE, RoHS approved

**Blender immersione alta prestazione**

Heavy-duty immersion blender	Cod.	L cm*
	5600-WSB50CE	30,5
	5600-WSB55CE	35,5
	5600-WSB60CE	40,5
	5600-WSB65CE	45,5



* Lunghezza albero / Shaft length

- **Motore per carichi di lavoro intensi con 1 CV di potenza di ingresso di picco**
1 peak input HP heavy-duty motor
- **Motore a velocità variabile da 650 W: 18.000 giri/min su HIGH (ALTO)**
650 W variable speed motor - 18,000 RPM on HIGH
- **Funzione accensione (ON) continua**
Continuous ON feature
- **Giunti sostituibili dall'utente su gruppo di alimentazione e albero**
User-replaceable couplings on power pack and shaft
- **Lama polivalente in acciaio inossidabile**
All-purpose stainless steel blade
- **Comoda impugnatura gommata e seconda maniglia per un funzionamento sicuro e sotto controllo**
Rubberized comfort grip and second handle for safe and controlled operation
 - **L'albero in acciaio inox completamente a tenuta è facilmente rimovibile e lavabile in lavastoviglie**
Completely sealed stainless steel shaft is easily removable and dishwasher safe
 - **I gruppi di alimentazione universali si adattano a tutti gli alberi e all'attacco del frullino**
Universal power packs fit all shafts and whisk attachment
- **230 VCA, 50 Hz, 2,8 amp**
- **Approvato CE, RoHS**
CE, RoHS approved

**Blender immersione standard**

Standard immersion blender	Cod.	L cm*
	5600-WSB40E	25,5



* Lunghezza albero / Shaft length

- **Motore da 0,5 CV a 2 velocità per carichi di lavoro intensi**
½ HP, 2-speed heavy-duty motor
- **Albero da 25,5 cm fisso**
25.5 cm fixe shaft
- **Comoda impugnatura gommata**
Rubberized comfort grip
- **Lama polivalente in acciaio inossidabile**
All-purpose stainless steel blade
- **23 litri di capacità**
23-liter capacity
- **230 volt, 50 Hz, 1,5 amp**
- **Approvato CE, RoHS**
CE, RoHS approved

**Attacco frusta per blender alta prestazione**

Heavy-duty whisk whipping attachment	Cod.	L cm
	5600-WSB2W	25,5



- **Palette per montare da 25,5 cm in acciaio inossidabile**
25.5-cm stainless steel whipping paddles
- **Si adatta all'intera linea di mixer a immersione Big Stix per carichi di lavoro intensi**
Fits entire Big Stix Heavy-Duty Immersion Blender line
- **Giunto sostituibile dall'utilizzatore**
User-replaceable coupling
- **Ingranaggi pressofusi per prestazioni ottimali**
Die-cast gears for optimal performance
- **Approvato CE, RoHS**
CE, RoHS approved



Mixer bevande a testina singola

Drink mixer,
single spindle

Cod.
5620-WDM120TX



- **Il motore ad alte prestazioni è sostituibile dall'utente per il funzionamento continuo e include una protezione termica per prolungarne la vita**
Independent, high-performance motor are user-replaceable for continued operation and includes thermal protection to prolong motor life
- **I comandi elettronici a 3 velocità (15.000, 18.000 e 21.000 giri/min) e a impulsi mantengono la velocità sotto carico per prestazioni ottimali**
Electronic 3-speed and pulse controls maintain speed under load for optimal performance - 15,000, 18,000 and 21,000 RPM
- **Gli attuatori completamente chiusi impediscono l'ingresso della miscela nell'alloggiamento**
Fully enclosed actuators prevent mix from entering the housing
- **2 agitatori sulla testina: un agitatore solido per la miscelazione di gelati duri e l'aerazione per una maggiore resa e un agitatore a farfalla per gelati e miscele più morbide**
2 agitators on the spindle: one solid agitator for mixing hard ice creams and aerating for increased yield, and one butterfly agitator for softer ice creams and mix-ins
- **Posizionamento del bicchiere senza doverlo inclinare**
Increased cup clearance: slide cups into position without tilt
- **Funzionamento START/STOP completamente automatico, attivato dalla tazza, con una sola mano**
Fully automatic, cup-activated, one-handed START/STOP operation
- **Resistente, verniciato a polvere, alloggiamento in acciaio pressofuso**
Heavy-duty, powder-coated, die-cast steel housing
- **Bicchieri in acciaio in dotazione da 800 ml**
Stainless steel malt beverage cup (800 ml) included
- **220 VCA, 60 Hz**
- **Approvato CE, RoHS**
CE, RoHS approved



Mixer bevande a testina doppia o tripla

Drink mixer, double
or triple spindle

Cod.
5620-WDM240E
5620-WDM360E

Testina/Spindle
doppia/double
tripla/triple



- **2 motori (WDM240) o 3 motori (WDM360) indipendenti per carichi di lavoro intensi per complessivi 1,3 CV a 3 velocità (16,000, 20,000 e 24,000 giri/min) e impulso**
Two (WDM240) or three (WDM360) independent 1 peak HP motor, three-speed rocker switch (16,000, 20,000 and 24,000 RPM) and PULSE switch
- **Accensione e spegnimento automatico, a velocità impostata, semplicemente inserendo o togliendo il bicchiere dall'alloggiamento**
Fully automatic START/STOP operation
- **Motor will run at selected speed once cup is in position**
- **Posizionamento del bicchiere senza doverlo inclinare**
Slide cups into position without tilt
- **Struttura in metallo pressofuso adatto ad un uso intenso**
Heavy-duty die-cast housing – easy to clean
- **Agitatore solido di nuova concezione per dare risultati migliori anche con i gelati più duri**
Brand new ultra-aggressive agitator powers through the hardest ice creams
- **Agitatore a farfalla incluso nella confezione, per gelati morbidi e per diverse tipologie di bicchieri**
Also includes butterfly agitator for softer ice creams and use with many types of cups
- **Bicchieri in acciaio in dotazione da 800 ml**
Stainless steel malt beverage cups (800 ml) included
- **Motori con protezione termica.**
Motors incorporate thermal protection
- **Cuscinetto a sfera autolubrificante per un uso intenso e duraturo**
Sealed ball bearings – ball bearings are lubed for life with no need to replace, providing long service life
- **220 VCA, 60 Hz, 110 W, 1,15 amp**
- **Approvato CE, RoHS**
CE, RoHS approved



WDM240E

WDM360E

Mixer per bevande a tripla testina

Triple-spindle drink mixer

Cod.
5620-DMC201DCAE



- **Motori commerciali ad alte prestazioni, 1 CV di potenza di ingresso di picco a 2 velocità - 24.000 giri/min su High (Alto)**
Three high-performance 1 peak HP, 2-speed commercial motors - 24,000 RPM on HIGH
- **Alloggiamenti per motore in metallo pressofuso per carichi di lavoro intensi**
Heavy-duty die-cast metal motor housings
- **Funzionamento start/stop (avvio/arresto) automatico**
Fully automatic START/STOP operation
- **Pannello spruzzi in acciaio inossidabile pesante, facile da pulire**
Heavy-duty easy-to-clean stainless steel splash panel
- **230 VCA, 50 Hz, 360 W, 1,56 amp**
- **Approvato CE, RoHS**
CE, RoHS approved





SISTEMA DI TENUTA LIQUILOCK®
LIQUILOCK® SEAL SYSTEM



Cutter tagliaverdura 3,8 L 2 CV con espulsore

3.8 L cutter mixer
and continuous-feed
food processor

Cod. cl
5605-WFP16SCDE 380



- **Sistema di tenuta LiquiLock**
LiquiLock Seal System
- **Alloggiamento pressofuso per carichi di lavoro intensi**
Heavy-duty, die-cast housing
- **Motore commerciale da 2 CV (picco potenza)**
2 HP (peak input) commercial motor
- **Scivolo ad alimentazione continua per lavorazione di grandi volumi**
Continuous-feed chute for large-volume processing
- **La ciotola del mixer con taglierina sigillata da 3,8 L lavora facilmente zuppe, salse, condimenti e altro**
3.8 L sealed cutter mixer bowl processes soups, sauces, dressings and more with ease
- **Oltre 20 opzioni di lavorazione in una sola macchina**
Over 20 processing options in one machine
- **Elaborazione unica della ciotola; sminuzzare, grattugiare e affettare direttamente nella ciotola con il gambo del disco incluso**
Unique batch bowl processing; shred, grate and slice directly in the batch bowl with the included disc stem
- **220-240 VCA, 50-60 Hz, 700 W**
- **Approvato CE, RoHS**
CE, RoHS approved

ACCESSORI INCLUSI CON I MODELLI WFP16 ACCESSORIES INCLUDED WITH WFP16 FOOD PROCESSORS



KIT PER TAGLIO A CUBETTI (10 MM)
10 MM-3/8" DICING KIT
(SOLO CON/ONLY WITH WFP16SCDE)



LAMA A S SIGILLATA E BLOCCATA
SEALED & LOCKED S-BLADE



DISCO PER MONTARE SIGILLATO E BLOCCATO
SEALED & LOCKED WHIPPING DISC



DISCO AFFETTATORE REGOLABILE (1-6 MM)
ADJUSTABLE SLICING DISC (1-6 MM)



DISCO SMINUZZATORE REVERSIBILE (FINE/SPESSE)
REVERSIBLE SHREDDING DISC (FINE/COARSE)

Cutter tagliaverdura da cucina 3,8 L, 0,65 CV

3.8 L cutter mixer
food processor

Cod. cl
5605-WFP16SE 380



- **Sistema di tenuta LiquiLock**
LiquiLock Seal System
- **Alloggiamento pressofuso per carichi di lavoro intensi**
Heavy-duty, die-cast housing
- **Ciotola del miscelatore con taglierina da 3,8 L, praticamente infrangibile e ben visibile con sistema di tenuta LiquiLock® per la lavorazione di liquidi**
3.8 L, virtually unbreakable, clear-view cutter mixer bowl with LiquiLock® Seal System for processing liquids
- **Motore commerciale da 650 W**
650 W commercial motor
- **Pulsanti di controllo grandi e di facile lettura**
Large, easy-to-read control buttons
- **Oltre 20 opzioni di lavorazione in una sola macchina**
Over 20 processing options in one machine
- **Elaborazione unica della ciotola; sminuzzare, grattugiare e affettare direttamente nella ciotola con il gambo del disco incluso**
Unique batch bowl processing; shred, grate and slice directly in the batch bowl with the included disc stem
- **220-240 VCA, 50-60 Hz, 700 W**
- **Approvato CE, RoHS**
CE, RoHS approved



PIÙ PRODUZIONE IN MENO TEMPO. NESSUN DISORDINE

Il sistema di tenuta LiquiLock® brevettato da Waring consente una maggiore produzione in meno tempo.

Otteni il massimo dalla capacità della tua ciotola senza alcuna perdita di liquido.

La lama a S si blocca in sede, sigillando il fondo della ciotola, rendendo più sicuro, più pulito e più facile versare le miscele senza che la lama cada nella ciotola degli alimenti lavorati.

La guarnizione rimovibile nel coperchio con chiusura a scatto impedisce al liquido di fuoriuscire dalla parte superiore della ciotola, consentendo di riempirla fino all'orlo.

MORE PRODUCTS. LESS TIME. NO MESS

Waring's patented LiquiLock® Seal System allows for more production in less time. Get the most out of your bowl capacity with bottom- to top-of-the-bowl liquid processing with no leaking.

The patented S-blade locks into place, sealing the bottom of the bowl, making it safer, cleaner, and easier to pour mixtures without the blade falling out into the processed food bowl.

The removable seal in the snap-lock lid prevents any liquid from escaping the top of the bowl.

Fill it to the rim without overflowing.





**Cutter tagliaverdura 3,3 L
1 CV con espulsore**

3.3 L cutter mixer and continuous-feed food processor
Cod. 5605-WFP14SCE cl 330



- **Sistema di tenuta LiquiLock**
LiquiLock Seal System
- **Motore da 1 CV ad alte prestazioni**
High-performance 1 HP motor
- **Palette di controllo agevoli, per accensione (ON) e impulso/spengimento (PULSE/OFF)**
Easy ON and PULSE/OFF control paddles
- **Tubo di immissione e spingicibo di grandi dimensioni**
Extra-large feed tube and food pusher
- **Scivolo per immissione continua in policarbonato con maniglie, per preparare grandi volumi**
Continuous-feed rugged black polycarbonate chute for large volume processing
- **Resistente coperchio trasparente**
Durable see-through cover
- **230 VCA, 50 Hz, 2,6 amp**
- **Approvato CE, RoHS**
CE, RoHS approved

Cutter tagliaverdura da cucina 3,3 L, 1 CV

3.3 L cutter mixer food processor
Cod. 5605-WFP14SE cl 330



- **Sistema di tenuta LiquiLock**
LiquiLock Seal System
- **Motore da 1 CV ad alte prestazioni**
High-performance 1 HP motor
- **Palette di controllo agevoli, per accensione (ON) e impulso/spengimento (PULSE/OFF)**
Easy ON and PULSE/OFF control paddles
- **Tubo di immissione e spingicibo di grandi dimensioni**
Extra-large feed tube and food pusher
- **Bicchiere dosatore a tenuta**
Sealed batch bowl
- **230 VCA, 50 Hz, 2,6 amp**
- **Approvato CE, RoHS**
CE, RoHS approved



ACCESSORI INCLUSI CON I MODELLI WFP14
ACCESSORIES INCLUDED WITH WFP14 FOOD PROCESSORS



LAMA A S SIGILLATA E BLOCCATA
SEALED & LOCKED S-BLADE



DISCO PER MONTARE SIGILLATO E BLOCCATO
SEALED & LOCKED WHIPPING DISC



DISCO PER GRATTOGGIARE
GRATING DISC



DISCO AFFETTATORE REGOLABILE (1-6 MM)
ADJUSTABLE SLICING DISC (1-6 MM)



DISCO SMINUZZATORE REVERSIBILE (FINE/SPESO)
REVERSIBLE SHREDDING DISC (FINE/COARSE)

Cutter tagliaverdura da cucina 1,75 L, 0,75 CV

1.75 L commercial food processor
Cod. 5605-WFP7E cl 175



- **Motore da 0,75 CV ad alte prestazioni per carichi di lavoro intensi**
Heavy-duty ¾ HP high performance motor
- **Bicchiere da lavoro infrangibile e trasparente**
Clear-view unbreakable workbowl
- **Facilità di controllo ON (accensione), OFF (spegnimento) e PULSE (impulso)**
Easy ON/OFF/PULSE control
- **Lama a S seghettata in acciaio inossidabile per trinciare, macinare, miscelare e passare, disco affettatore da 2 mm, disco grattugia sottile e stelo del disco staccabile**
Stainless steel serrated S-blade to chop, grind, mix and purée, disc, fine grating disc, and detachable disc stem
- **Spingicibo di dimensioni piccole e grandi con manicotto di interblocco di sicurezza**
Small and large pushers with safety interlock sleeve
- **230 VCA, 50 Hz, 410 W, 1,8 amp**
- **Approvato CE, RoHS**
CE, RoHS approved



Macina spezie

Commercial spice grinder
Cod. 5660-WSG30E



- **Macina finemente bastoncini di cannella, noce moscata, granelli di pepe nero e molto altro in pochi secondi**
Finely grinds cinnamon sticks, nutmeg, peppercorns and much more in seconds
- **Motore di qualità commerciale a elevate prestazioni 19.000 giri/min.**
High-performance commercial-grade motor - 19,000 Rpm
- **Alloggiamento per carichi di lavoro intensi in acciaio inossidabile opacizzato con coperchio a interblocco di sicurezza**
Heavy-duty brushed stainless steel housing with safety interlock lid
- **Azionamento PULSE (Impulso) per gestire facilmente le dimensioni della macinatura**
PULSE actuation to easily manage consistency of grind
- **In dotazione 3 bicchieri di macinatura completamente rimovibili, lavabile in lavastoviglie in acciaio inox con comodi coperchi per la conservazione**
Includes 3 fully removable and dishwasher-safe stainless steel grinding bowls with convenient storage lids
- **Lame resistenti in acciaio inossidabile**
Durable stainless steel blades
- **230 VCA, 50 Hz, 175 W, 0,76 amp**
- **Approvato CE, RoHS**
CE, RoHS approved



Planetaria

Planetary mixer

Cod.

5605-WSM7LE



- **Trasmissione ad ingranaggi, lubrificazione permanente**
Gear-driven, permanent lube transmission
- **Grande ciotola in acciaio inossidabile da 6,6 L con manico in acciaio inossidabile**
Large, 6.6 L stainless steel bowl with stainless steel handle
- **Controlli frontali e LED luce di alimentazione**
Front-mounted controls and LED power light
- **11 velocità di miscelazione con manopola di controllo della velocità variabile**
11 mixing speeds with variable speed control dial
- **Paraspruzzi rimovibile e trasparente con scivolo di alimentazione**
Removable clear-view splash guard with feed chute
- **Testa inclinabile per una facile rimozione degli accessori e pulizia**
Tilt-back head for easy removal of attachments and cleaning
- **Leva di sollevamento/rilascio per impieghi gravosi**
Heavy-duty head-lift/release lever
- **Protezione da sovraccarico termico**
Thermal overload protection
- **Include ciotola in acciaio inossidabile, frusta da chef, gancio per impastare e pala per mescolare in alluminio**
Includes stainless steel bowl, chef's whisk, dough hook and aluminum mixing paddle
- **Accessori lavabili in lavastoviglie**
Dishwasher-safe accessories
- **Piedini in gomma antiscivolo**
Nonslip rubber feet
- **220-240 V, 50-60 Hz, 350 W**

ACCESSORI INCLUSI CON IL MODELLO WSM7LE
ACCESSORIES INCLUDED WITH WSM7LE PLANETARY MIXER



PALETTA PER MISCELARE
MIXING PADDLE



FRUSTA CHEF'S WHISK



GANCIOPER IMPASTARE
DOUGH HOOK



CIOTOLA IN ACCIAIO INOX
STAINLESS STEEL BOWL

**Gelatiera a compressore**

Electric ice cream maker

Cod.

5680-WCIC20E

cl

200



- **Il compressore integrato non richiede precongelo**
Built-in compressor means NO pre-freezing required
- **Prepara fino a 2 L di gelato, frozen yogurt o gelato in soli 30 minuti**
Make up to 2 L of ice cream, frozen yogurt or gelato in as little as 30 minutes
- **Esterno in acciaio inossidabile e comandi touch facili da pulire**
Easy-to-clean stainless steel exterior and touch controls
- **La funzione Keep Cool mantiene il gelato alla temperatura ottimale al termine del processo**
Keep Cool feature holds ice cream at the optimal temperature when process is finished
- **220-240 V, 50 Hz, 180 W**
- **Approvato CE, RoHS**
CE, RoHS approved



FACILE AGGIUNTA DEGLI INGREDIENTI SENZA INTERRUPTERE IL PROCESSO
MIX-INS COMBINE EASILY WITHOUT INTERRUPTING THE PROCESS



CIOTOLA RIMOVIBILE PER UNA FACILE PULIZIA
REMOVABLE BATCH BOWL FOR EASY CLEANING



Affilatore per coltelli

Commercial knife sharpener Cod.

5665-WKS800E



- **Due mole (grani fini/grossi), una coramella rotante**
Two grinding wheels (fine/coarse) one stropping wheel
- **Mola ad angoli di 18-22°: gli angoli consigliati dai produttori di coltelli**
Grinds at 18-22° angles - optimum angles recommended by knife manufacturers
- **La coramella rotante funziona anche in senso inverso, consentendo un'eliminazione più efficace delle sbavature e la levigatura della lama**
Stropping wheel also operates in reverse direction, allowing for a more efficient removal of burrs and polishing of the blade
- **Un cassetto magnetizzato sotto la mola raccoglie le schegge metalliche rasate**
Magnetized drawer under grinding wheel captures metal shavings
- **230 VCA, 50/60 Hz, 25 W, 0,1 amp**
- **Approvato CE, RoHS**
CE, RoHS approved



Pistola per sottovuoto

Commercial vacuum sealing system Cod.

5670-WV550



- **Controllo manuale dell'intensità del sottovuoto, ottima per prodotti delicati**
Trigger operation allows for vacuuming delicate and softer products
- **Base di ricarica e stoccaggio sacchetti**
Heavy-duty enclosed storage/charging base
- **Batteria ricaricabile (un'ora e mezza di autonomia) sigilla fino a 50 sacchetti con una carica**
Rechargeable NiMH battery, seal up to 50 bags with one full charge
- **Possibilità di utilizzo con rete elettrica (cavo incluso)**
Optionally, it can be connected to electricity (cable is included)
- **Inclusi 25 sacchetti da 3,8 litri e 25 sacchetti da 0,95 litri, adatti a microonde, freezer e roner**
Includes 25 one-quart (0.95 l) and 25 one-gallon (3.8 l) storage bags, microwave safe, freezer safe, boil safe
- **230 VCA, 60 Hz**
- **Approvato CE, RoHS**
CE, RoHS approved



Spremiagrumi compatto per bar

Compact citrus bar juicer Cod.

5630-BJX240



- **Il design compatto crea un centro capace di fornire profitti a ingombro ridotto**
Compact design creates small-space profit center
- **Motore base silenzioso per carichi di lavoro intensi**
Heavy-duty base; quiet motor
- **Lo spremitore si adatta a tutti gli agrumi**
Reamer fits all citrus fruits
- **Il bicchiere per il succo e lo spremitore si sollevano per facilitare le operazioni di pulizia**
Juice bowl, reamer lift off for easy cleaning
- **In dotazione contenitore da 1 litro per servire**
Includes 1-liter serving container
- **230 VCA, 50 Hz, 110 W, 0,5 amp**
- **Approvato CE, RoHS**
CE, RoHS approved

Centrifuga in acciaio inox con espulsione della polpa

Heavy-duty pulp eject juice extractor Cod.

5630-WJX90E



- **Consigliato per carichi di lavoro intensi in bar, caffetterie, ristoranti, hotel e strutture sanitarie**
Use in high-volume smoothie shops, cafés, bars, restaurants, hotels and healthcare establishments
- **Cestello filtro in acciaio inox e disco tritatore progettati per una resa ottimale e una riduzione degli sprechi**
Stainless steel filter basket and shredder disc designed for a fantastic yield to minimize waste
- **Compatto e leggero**
Compact and lightweight
- **Facile da pulire (tutte le parti sono lavabili in lavastoviglie)**
Easy to clean with all dishwasher-safe parts
- **Ampio scivolo di alimentazione da 8 cm**
Large, 8 cm feed chute for less prep work
- **Grande contenitore per polpa da 11 L**
Large, 11 L pulp container
- **Interblocco di sicurezza**
Includes safety interlock features
- **Beccuccio rotante antigoccia**
Rotating, no-drip spout reduces mess
- **220-240 V, 50-60 Hz, 1000 W**
- **Approvato CE**
CE approved



Centrifuga in acciaio inox

Heavy-duty juice extractor Cod.

5630-6001X



- **Trasforma rapidamente frutta e verdura in un ricco succo privo di polpa**
Rapidly converts fruits and vegetables into rich, pulp-free juice
- **La lama ad azione oscillante velocizza il flusso del succo con una più rapida distribuzione della polpa**
Floating action stainless steel blade speeds up juice flow with faster distribution of pulp
- **Cestello, bicchiere e coperchio di spremitura in acciaio inossidabile**
Stainless steel extraction basket, bowl, and cover
- **Alloggiamento del motore in policarbonato**
Polycarbonate motor housing
- **230 VCA, 50 Hz, 1,4 amp**
- **Approvato CE, RoHS**
CE, RoHS approved





WSW16E



WSW25E

Macchina per cottura sottovuoto

Thermal circulator	Cod.	Lt
	5670-WSW16E	16
	5670-WSW25E	25



- **Costruzione interamente in acciaio inossidabile**
All-stainless steel construction
- **5 stazioni di memoria programmabili e timer da 99 ore**
5 programmable memory stations and 99-hour timer
- **Precisione della temperatura di +/- 0,5° C**
Temperature accuracy of +/- 0.5° C
- **Sistema di tubi integrato per rimuovere facilmente e in sicurezza l'acqua dal serbatoio**
Integrated hose system to easily and safely remove water from reservoir
- **Il controllo touch capacitivo consente di impostare o regolare rapidamente la temperatura di cottura**
Capacitive touch control enables you to quickly set or adjust the cooking temperature
- **Intervallo di temperatura da 35°C a 90°C**
Temperature range from 35°C to 90°C (95° F - 194° F)
- **Perfetto per tutti i ristoranti e ideale per il catering**
Perfect for all restaurants and off-premises cooking.
- **220-240 V, 50-60 Hz, 2000 W**
- **Approvato CE, RoHS**
CE, RoHS approved



CONDITE IL CIBO COME DESIDERATE E METTETELO SOTTOVUOTO. I SUCCHI E LE SOSTANZE NUTRITIVE NATURALI VENGONO MANTENUTI DURANTE LA COTTURA

SEASON FOOD WITH YOUR FAVORITE HERBS AND SPICES, THEN VACUUM SEAL. NATURAL JUICES AND NUTRIENTS ARE RETAINED WHILE COOKING



POTETE PREPARARE E CUOCERE PIU' PORZIONI IN ANTICIPO. IL CONTROLLO PRECISO DELLA TEMPERATURA E LA CIRCOLAZIONE CONTINUA DELL'ACQUA, GARANTISCONO UNA COTTURA PERFETTA

PREPARE AND COOK MULTIPLE PORTIONS AHEAD OF TIME. WITH PRECISE TEMPERATURE CONTROL AND CONTINUOUS WATER CIRCULATION, FOOD CANNOT BE UNDER- OR OVERCOOKED



Disidratatore per alimenti

Food dehydrator	Cod.
	5655-WDH10E



- **Creato per chef e mixologist che desiderano aggiungere sapori e consistenze particolari a cibi e bevande**
Built for chefs and mixologists looking to add unique flavor and texture to food and beverages
- **Display a LED digitale con comandi touch capacitivi**
Digital LED display with capacitive touch controls
- **5 stazioni di memoria per l'impostazione e la memorizzazione di programmi personalizzati**
5 memory stations for setting and storing unique programs
- **Intervallo di temperatura regolabile: 0° C - 80° C**
Adjustable temperature range: 0° C - 80° C (32° F - 176° F)
- **Visualizza la temperatura in °C o °F**
View temperature in °C or °F
- **Imposta il timer fino a 99 ore, spegnimento automatico quando il tempo finisce**
Set timer up to 99 hours, automatic shutoff when times lapses
- **10 vassoi di spazio disidratante**
10 trays of dehydrating space
- **Griglia in acciaio inox 38 x 34 cm**
38 x 34 cm stainless steel mesh racks
- **Superficie totale disidratante di 1,3 mq**
Total dehydrating surface area of 1,3 square meters
- **Porta in vetro trasparente per il monitoraggio del processo di disidratazione**
Clear-view glass door for monitoring dehydrating process
- **Sistema di flusso d'aria montato posteriormente**
Rear-mounted airflow system
- **220-240 V, 50-60 Hz, 800 W**
- **Approvato CE, RoHS**
CE, RoHS approved

Grill per panini

Compact Italian-Style panini grill

Cod.

5645-WPG150E

singolo/single

5645-WPG300E

doppio/double



- **Piastre in ghisa rigate per una distribuzione uniforme del calore e un rapido tempo di cottura**
Ribbed cast iron plates for even heat distribution and quick cooking time
- **Superfici di cottura ideali per grigliare panini, hamburger, pollo, verdure e altro**
24 x 23,5 cm (WPG 150E) - 43,25 x 23,5 cm (WPG300E)
Cooking surfaces great for grilled panini, sandwiches, hamburgers, chicken, vegetables and more
24 x 23,5 cm (WPG150E) - 43,25 x 23,5 cm (WPG300E)
- **Corpo in acciaio inossidabile opacizzato e vassoio di gocciolamento rimovibile**
Brushed stainless steel body construction and removable drip tray
- **Piastra superiore incernierata autoequilibrante per accogliere alimenti spessi fino a 7,5 cm**
Hinged, auto-balancing top plate to suit foods up to 7.5 cm thick
- **Termostato regolabile fino a 300°C**
Adjustable thermostat to 300°C (572°F)
- **Spie: Alimentazione e Pronto**
Power ON and Ready indicator lights
- **Maniglie resistenti al calore**
Heat resistant handles
- **230 VCA, 2100 Hz, 8,7 amp (WPG150E)**
230 VCA, 2900 Hz, 12,1 amp (WPG300E)
- **Approvati CE, RoHS**
CE, RoHS approved



WPG150E



WPG300E

Friggitrice doppia da 5 L

Double 5 L deep fryer

Cod.

5650-WDF1000DE



- **Due vasche indipendenti in acciaio inox da 5 L cadauna, removibili per una facile pulizia**
Dual, independent, 5 L stainless steel tanks, removable for easy cleaning
- **Elementi riscaldanti incernierati**
Hinged heating elements
- **Timer regolabile fino a 30 minuti**
30-minutes timer
- **Temperatura regolabile fino a 200° C**
Variable temperature controls up to 200° C
- **Fornita con 2 cestelli grandi, 4 piccoli e 2 coperchi**
Includes 2 large single baskets, 4 twin baskets and 2 night covers
- **230 VCA, 2850 Hz, 12,4 amp (per unità/unit)**
- **Approvato CE, RoHS**
CE, RoHS approved



Piastra per cialde cono (singola o doppia)

Waffle cone maker
(single or double)

Cod.

5655-WWCM180E
5655-WWCM200E

Single
Double



- **Alloggiamento pressofuso per carichi di lavoro intensi**
Heavy-duty, die-cast housing
- **Funzione rotante per cottura e doratura uniformi**
Rotary feature for a secure and even bake
- **Le piastre antiaderenti a triplo rivestimento consentono una facile estrazione delle cialde e una rapida pulizia**
Triple-coated, nonstick surface allows for easy removal of waffle cones and minimizes cleanup
- **Tastiera di controllo elettronica facile da pulire**
Easy-to-clean electronic keypad controls
- **Spia luminosa per quando l'apparecchio è pronto e segnalazione acustica per quando la cialda è cotta**
Ready lights and audio chimes signal when unit is ready and when waffle cone is done
- **WWCM180E**
Produce fino a 60 cialde ogni ora
Bakes up to 60 waffle cones per hour
- **WWCM200E**
Produce fino a 120 cialde ogni ora
Il design verticale salva spazio e riduce il consumo energetico
Bakes up to 120 waffle cones per hour
Vertical design maximizes output, using less space and less energy
- **230 VCA, 60 Hz**



ACCESSORIO PER L'AVVOLGIMENTO DELLA CIALDA INCLUSO
INCLUDES A WAFFLE CONE ROLLING AND FORMING TOOL

Pressa per panini gelato

Ice cream sandwich press

Cod.

5680-WICSP180E



- **Alloggiamento pressofuso per carichi di lavoro intensi**
Heavy-duty die-cast housing
- **Le piastre antiaderenti a triplo rivestimento consentono una facile estrazione dei panini e una rapida pulizia**
Triple-coated nonstick plates allow for easy panini removal and quick cleanup
- **Resistenza incorporata per sigillare perfettamente i tuoi panini gelato**
Embedded heating element to perfectly seal your gelato panini
- **Pannello di controllo elettronico dalla facile pulizia**
Electronic control panel for easy cleanup
- **Segnalazioni acustiche quando l'apparecchio è pronto e quando la cialda è cotta**
Audio beep signals when unit is ready and when bun is warmed
- **Tempi di cottura da 5 a 15 secondi per un perfetto panino gelato**
Bake times from 5-15 seconds for the perfect gelato panini
- **Indicatori LED di accensione e pronto per la cottura**
Power ON and Ready-to-Bake LED indicators
- **220-240 V, 50-60 Hz, 1200 W**
- **Approvato CE, RoHS**
CE, RoHS approved

Piastra per waffle (singola o doppia)

Belgian waffle maker
(single or double)

Cod.
5655-WW180E Single
5655-WW200E Double



- **Alloggiamento pressofuso per carichi di lavoro intensi**
Heavy-duty die-cast housing
- **Funzione rotante per cottura e doratura uniformi**
Rotary feature for even baking and browning
- **Le piastre antiaderenti a triplo rivestimento consentono una facile estrazione delle cialde e una rapida pulizia**
Triple-coated nonstick plates allow for easy removal of waffle and quick cleanup
- **Elementi riscaldanti integrati per un controllo esatto della temperatura**
Embedded heating elements for precise temperature control
- **Segnalazioni acustiche quando l'apparecchio è pronto e quando la cialda è cotta**
Audio beep signals when unit is ready and when waffle is cooked
- **WW180E**
Produce fino a 25 waffle alla belga ogni ora
Produces up to 25 Belgian waffles per hour
- **WW200E**
Produce fino a 50 waffle alla belga ogni ora
Nuovo design verticale salvaspazio con luce "Pronto" indipendente
Produces up to 50 Belgian waffles per hour
New space-saving vertical design with independent 'Ready' lights
- **230 VCA, 50 Hz**
- **Approvato CE, RoHS**
CE, RoHS approved



WW180E

WW200E



Piastra per mini waffle

Single mini Belgian
waffle maker

Cod.
5655-WMB400XCE



- **Alloggiamento pressofuso per carichi di lavoro intensi**
Heavy-duty die-cast housing
- **Funzione rotante per cottura e doratura uniformi**
Rotary feature for even baking and browning
- **Le piastre antiaderenti a triplo rivestimento consentono una facile estrazione delle cialde e una rapida pulizia**
Triple-coated nonstick plates allow for easy removal of waffle and quick cleanup
- **Segnalazioni acustiche quando l'apparecchio è pronto e quando la cialda è cotta**
Audio beep signals when unit is ready and when waffle is cooked
- **Produce fino a 100 mini waffle belgi spessi 2,5 cm e con diametro di 7 cm all'ora**
Produces up to 100, 2,5 cm-thick (1 inch) and 7 cm in diameter mini Belgian waffles per hour
- **Le piastre per waffle possono essere facilmente sostituite se graffiate**
Waffle plates can be easily replaced if scratched
- **Indicatori LED di accensione e pronto per la cottura**
Power ON and Ready-to-Bake LED indicators
- **220-240 V, 50-60 Hz, 1035 W**
- **Approvato CE, RoHS**
CE, RoHS approved



Piastra per bubble waffle

Bubble waffle maker

Cod.
5655-WBW300XCE



- **Alloggiamento pressofuso per carichi di lavoro intensi**
Heavy-duty die-cast housing
- **Funzione rotante per cottura e doratura uniformi**
Rotary feature for even baking and browning
- **Le piastre antiaderenti a triplo rivestimento consentono una facile estrazione delle cialde e una rapida pulizia**
Triple-coated nonstick plates allow for easy removal of waffle and quick cleanup
- **Segnalazioni acustiche quando l'apparecchio è pronto e quando la cialda è cotta**
Audio beep signals when unit is ready and when waffle is cooked
- **Produce fino a 25 bubble waffle all'ora**
Produces up to 25 bubble waffles per hour
- **Una volta cotti i bubble waffle possono essere guarniti con gelato e/o ripieni**
Bake bubble waffles to top with ice cream and/or fillings
- **Le piastre per waffle possono essere facilmente sostituite se graffiate**
Waffle plates can be easily replaced if scratched
- **Indicatori LED di accensione e pronto per la cottura**
Power ON and Ready-to-Bake LED indicators
- **220-240 V, 50-60 Hz, 1035 W**
- **Approvato CE, RoHS**
CE, RoHS approved



WAFFLE 21 x 18 cm
30 BUBBLES



Tostapane 4 fette

Medium duty toaster

Cod.

5640-WCT708E



- **Alloggiamento in acciaio al cromo opacizzato**
Brushed chrome steel housing
- **Quattro fessure extralarghe da 3,5 cm per panini**
Four extra-wide 3.5 cm slots, great for bagels
- **225 fette all'ora**
225 slices per hour
- **Comandi per la doratura elettronici**
Electronic browning controls
- **Quattro portafette autocentranti**
Four self-centering bread racks
- **Vassoi per le briciole rimovibili**
Removable crumb trays
- **230 V, 50 Hz, 1800 W, 7,8 amp**
- **Approvato CE, RoHS**
CE, RoHS approved



Forno a convezione GN 1/2

GN 1/2 convection oven

Cod.

5655-WCO500XE



- **Funzioni di cottura a convezione, arrosto, cottura al forno, rosticceria e griglia**
Convection bake, roast, bake and broil functions
- **Finiture adatte a carichi di lavoro intensi in acciaio inossidabile opacizzato e interno completamente in acciaio inossidabile**
Heavy duty stainless steel construction
- **46 cm - accoglie 4 teglie GN 1/2 (non incluse)**
46 cm - handles up to 4 GN 1/2 sheet pans (not included)
- **In dotazione teglia da forno/ vassoio di gocciolamento in acciaio inossidabile e tre griglie da forno nichelate**
1 sheet pan and 3 baking racks included
- **Finestra in vetro temperato trasparente**
Double-pane tempered glass door
- **220-240 VCA, 50 Hz, 1700 W, 7,4 amp**
- **Approvato CE, RoHS**
CE, RoHS approved

ACCESSORI E RICAMBI ACCESSORIES AND SPARE PARTS

COD.	DESCRIZIONE DESCRIPTION	ADATTO A SUITABLE FOR
5690-023909	Bicchiere 2 manici 4 litri 4.0 liters 2 Handle Container	CB 15
5690-033626	Bicchiere 1,4 litri in copoliestere BPA-Free 1.4 liter BPA-Free copolyester container	BB300 - BB320 - BB340
5690-035239	Bicchiere 1,4 litri 1.4 liter TBB Stackable Jar - clear	TBB145 - TBB160 - TBB175
5690-035256	Caricabatterie Charger adapter	WWS50
5690-503482	Bicchiere con gruppo lame Jar Assy / TBB series	TBB145 - TBB160 - TBB175
5690-503501	Lama a esse S Blade	WFP7
5690-CAC20	Bicchiere in acciaio inossidabile da 0,83 litri 0.83 liter stainless steel malt cup	DMC201DCAE WDM120E - WDM240E - WDM360E
5690-CAC66	Filtri per centrifuga (confezione da 200 pezzi) Filters for juice extractor (pack of 200 pieces)	6001X
5690-CAC72	Bicchiere 4 litri con lame e coperchio 4.0 liters container complete with blade and lid	CB15
5690-CAC90I	Bicchiere completo da 2 litri in acciaio con lame e coperchio 2 liters stainless steel container complete with blade assembly and lid	MX1000XTXEE - MX1050XTXEE - MX1100XTXEE MX1200XTXEE - MX1300XTXEE - MX1500XTXEE
5690-CAC93XI	Bicchiere completo impilabile da 1,4 litri in copoliestere BPA-Free con lame e coperchio 1.4 liter stackable jar BPA-Free copolyester complete with blade assembly and lid	MX1000XTXEE - MX1050XTXEE - MX1100XTXEE MX1200XTXEE - MX1300XTXEE - MX1500XTXEE
5690-CAC95I	Bicchiere completo impilabile da 2 litri in copoliestere BPA-Free con lame e coperchio 2 liters stackable BPA-Free copolyester container with lid and blade	MX1000XTXEE - MX1050XTXEE - MX1100XTXEE MX1200XTXEE - MX1300XTXEE - MX1500XTXEE
5690-CAC121S	Arrotola cono piccolo Small waffle cone tool	WWCM180 - WWCM200
5690-CAC132	Bicchiere copoliestere BPA-Free 1,4 litri con lame e coperchio 1.4 liter BPA-Free copolyester container with blade and lid	BB300 - BB320 - BB340
5690-CAC138	Bicchiere in acciaio 1,4 litri (48 oz) per blender 1.4 liter (48 oz) stainless steel container	BB300 - BB320 - BB340
5690-PCA45	Attacco agrumi Citrus attachment accessory	6001X
5690-WFP14S10	Disco affettatore regolabile Adjustable slicing disc	WFP14SE - WFP14SCE
5690-WFP14S11	Disco per montare Sealed whipping disc	WFP14SE - WFP14SCE
5690-WFP14S12	Disco sminuzzatore reversibile Reversible shredding disc	WFP14SE - WFP14SCE
5690-WFP113	Disco per grattugiare finemente 2 mm Fine grating disc 2 mm	WFP7E
5690-WFP116	Disco per affettare fine 2 mm Shredding disc 2 mm	WFP7E
5690-WFP118	Disco per affettare 4 mm 4 mm slicing disc (standard)	WFP7E
5690-WFP119	Disco per affettare 6 mm 6 mm thick slicing disc	WFP7E
5690-WFP144	Disco per tritare 4 mm Shredding disc 4 mm	WFP14E
5690-WFP145	Disco per affettare 2 mm Thin slicing disc 2 mm	WFP14E
5690-WFP146	Disco per affettare 4 mm Slicing disc 4 mm	WFP14E
5690-WSB01	Dispositivo per appendere a parete mixer a immersione Big Stix Wall mount hanger for Big Stix immersion blender	WSB50CE - WSB55CE - WSB60CE - WSB65CE - WSB70CE
5690-WSB50ST	Albero inossidabile da 30,5 cm 30.5 cm shaft assy with blade	WSB50CE - WSB55CE - WSB60CE - WSB65CE - WSB70CE
5690-WSB55ST	Albero inossidabile da 35,5 cm 35.5 cm shaft assy with blade	WSB50CE - WSB55CE - WSB60CE - WSB65CE - WSB70CE
5690-WSB60ST	Albero inossidabile da 40,5 cm 40.5 cm shaft assy with blade	WSB50CE - WSB55CE - WSB60CE - WSB65CE - WSB70CE
5690-WSB65ST	Albero inossidabile da 45,5 cm 45.5 cm shaft assy with blade	WSB50CE - WSB55CE - WSB60CE - WSB65CE - WSB70CE
5690-WSB70ST	Albero inossidabile da 53,5 cm 53.5 cm shaft assy with blade	WSB50CE - WSB55CE - WSB60CE - WSB65CE - WSB70CE
5690-WWSBBC	Morsa per bicchiere per funzionamento automatizzato Bowl clamp for Big Stix immersion blender	WSB50CE - WSB55CE - WSB60CE - WSB65CE - WSB70CE
5690-WSBPPCE	Gruppo di alimentazione (motore) per mixer a immersione Big Stix Heavy-duty Big Stix power pack	WSB50CE - WSB55CE - WSB60CE - WSB65CE - WSB70CE
5690-WVS2GL	Sacchetti per pistola sottovuoto 8 L - 25 pz. 8 L bags for commercial vacuum sealing system - 25 pcs.	WWS50
5690-WVSGL	Sacchetti per pistola sottovuoto 4 L - 50 pz. 4 L bags for commercial vacuum sealing system - 50 pcs.	WWS50
5690-WVSQQT	Sacchetti per pistola sottovuoto 1 L - 50 pz. 1 L bags for commercial vacuum sealing system - 50 pcs.	WWS50

INDICE PRODOTTI

INDEX OF PRODUCTS

Accessori per piatti	154
Affettapane	71
Affilacoltelli manuale	77
Affilatore coltelli	207
Agitatore	169
Alare per forno	103
Alzate per dolci	133-134-138
Appendipale da parete	103
Apribottiglie	170-182
Apriostriche	78
Arriccio burro	66
Assi pizzeria	98
Asta appendimestoli	56-157
Bacinelle gelato	23
Bacinelle	50-51
Bagnomaria	49
Barra ordinazioni	185
Base per bastardella	51
Bastardella	50
Batticarne	68
Bicchieri	174-192-193
Bicchieri per boston shaker	173
Blender	200-201
Blender a immersione	202
Bocchette per decorazione	113-114
Bordatore di bicchieri	189
Boston shaker	172
B-Pour tester dosaggi	28-161
Bruschino puliscibocchette	115
Cannucce	197
Caffettiera	166
Campana per piatto da portata ovale	151
Cappelli cuoco	125
Caraffe	193
Carrello per mandolina	70
Casseruole alte	34-36-38-40-41-44-46
Casseruola alta antiaderente	42
Casseruole basse	34-36-38-40-44
Casseruola bassa antiaderente	42
Casseruole bombate	35-37-45
Casseruole medie	34-36-38-40-44-46
Casseruola media antiaderente	42
Centrifuga	207
Ceppo in acciaio inox	69
Cestelli lavastoviglie	80-81
Cestini	149-156-194-195
Chinois	40-48
Colabrodo	65
Colini	30
Colino per cocktail	169-173
Colonne per secchiello	183
Coltelli cucina	72-78
Coltelli tavola	142-145
Conchiglia in plastica	155
Cono portasacchetto in polipropilene	112
Contentori Storplus	89
Contentore palline pasta per pizza	103
Contentori per pasticcini	124
Coperchi pentolame	35-37-38-41-45-46
Coperchi gastronom	84-87-88
Coppa per gelato	171
Copribottiglia	170
Cremiera	166
Cucchiaini miscelatori	180-181
Cucchiaini	142-145
Cucchiaini bibita	144-147-169
Cucchiaioni	47-52-144-145-147-157
Cucchiaini tavola	142-145
Cuocithé	171
Dash bottles	180
Decora limone	66
Decoratore multiuso	67
Disidratatore alimenti	208
Dispenser in polietilene	192
Fagioli di ceramica per cottura base torta	139
Falso fondo forato per GN	84-87-88
Fermatovaglia	170
Fermo per taglieri	79
Flair bottle	190
Forchetta per ostrica	147
Forchetta scavino per aragosta	147
Forchette tavola	142-145
Forchettoni per lumache	147
Forchettoni	53-49-51-65-144-145-157
Formaggiera in filo	148

Forno a convezione	212
Friggitrice doppia	209
Frullatori	200-201
Fruste	64
Ganci macelleria	68
Gastronorm inox	82-83
Gastronorm policarbonato	86-87
Gastronorm polipropilene	88
Gelatiera a compressore	206
Grattugie	62-64-71
Griglia inox	125-134
Griglia per decorazione	137
Grill per panini	209
Guanti forno e protezione	65-69
Imbuto colatore	134
Jiggers	169-176-177
Lame per mandolina	70-71
Lattiera	166
Lavaporzionatori	23
Legumiera	150
Levatorsolo	66
Liquido riscaldante per chafing dish	155
Lira taglia pan di Spagna	139
Macchina per cottura sottovuoto	208
Macinaspezie elettrico	205
Mandoline	70-71
Maniglie cascanti per GN	84
Mascherina per decorazione	137-138
Mestolini per ciliegie	168
Mestolini per salsa	144-147-151
Mestoli	53-55-56-58-144-157-168
Misurini	49-125
Mixer	198-203-205
Mixing glasses	174
Molle	12-17-32-108-160
"Mollunghe"	13
Morsa prosciutto base in legno	69
Mugs	178-179
Padella quadrata giapponese	45
Padelle	35-37-38-41-45-46
Padelle antiaderenti	35-37-39-42-45
Pala braci	93-101
Pale e palettini pizzeria	93-99-101
Pale e palettini pizzeria Gluten Free	102
Pale pasticceria e gastronomia	142-146
Paletta pesce	53-54
Palette	53-55-56-59-157
Pelalimoni	66-163-170
Pelasparagi	67
Pennelli pasticceria	119
Pentole	35-37-38-41
Pestelli	189-196
Pettine per decorazione pasticceria	135
Piastra per cialde cono	210
Piastre per waffle	211
Piatti da portata	150-152
Piatti espositori	70
Piatto per lumache	154
Pinza per crostacei	67
Pinze	14-15-109
Pistola per sottovuoto	207
Placca per forno	52
Planetaria	206
Poggivassoio	194
Portacondimenti	184-188
Portacucchiaini	170
Portaoggetti da bar	189
Porta saccapocche da muro	112
Portastecchi	148-154
Portatovaglioli	171-184-194
Portauova	154
Portavivande	70
Portazucchero	194
Porzionatori gelato	20-21
Porzionatore liquori	188
Porzionatore torta	114
Posacenere	171-185-191
Posate insalata	144-147
Pressa per panini gelato	210
Pressini caffè	166
Raccoglibriciole	154-185
Raschie	61-105-108-119
Rete protettiva per bar	190
Ricambi accessori elettrici	199-205
Riga limone	66-163

Riscaldatore elettrico per Chafing Dish	155
Robot da cucina	204-205
Rompighiaccio manuale	191
Rompighiaccio elettrico	198
Rostiera rettangolare alta	40
Rotella taglia pasta	118
Rotella taglia pizza	61-105
Rullo bucafoglia	119
Saccapocche	112-114
Salsiere	150
Sbuccia arancia	66-163
Sbucciaverdure	67
Scaldapasta	48
Scavini	66-163
Schiumarole	53-58-65-157
Scolapasta	51
Scolapasta manico lungo	65
Secchielli ghiaccio e vino	183
Secchi	51
Sega per ossa	69
Separatore per GN	84
Servizi per olio, aceto, sale, pepe	148
Sessole	49-111-183-194
Setacci	50
Set intaglio e decorazione	77-163
Shaker	172-174-175
Sifoni	184
Snocciolatore per olive	67
Soflex	110-111
Sottobicchieri e sottobottiglia	171
Sottocoppa per gelato	171
Sottopiatto	149
Sottotorta	124
Spalmaburro	144-145
Spargicacao	166
Spatole	60-61-104-114-118-134
Spazzole pizzeria	100-101
Spazzoloni pizzeria	93-100-101
Spatole per gelato	22
Speed bottle	187
Speed racks	184
Spicchio per casseruola	48
Spiedini inox	65
Spremiagrammi manuale	169
Spremiagrammi elettrico	198-207
Spremilimone	170-181
Spumantiera	183
Squamapesci	67
Stampi pasticceria	125-134-139
Stampi semifreddo	125
Steady Spout	29-162
Supporti per bottiglia	188
Supporto per imbuto colatore	134
Tagliabiscotti	120-124
Tagliacroissant	119
Tagliapasta	61-104-105-116-118-120-123
Tagliatartufi	155
Tagliauova	67
Taglieri	79-189
Tappeti bar	190
Tappeto antiaderente per dolci - Fiberlux	136
Tappi versatori	24-29-161-163
Tazzoni	49
Tegami	35-37-39-41-45-46
Tegame antiaderente	42
Tegamino per uova	154
Teglie	52
Teglia Gastronorm	83
Teiera	166
Telaio per stesura biscuit	135
Termometri	64
Terrina in policarbonato	89-155
Timballo per dolci	49
Tirabraci	93-101
Tortiere	126-129-134
Tostapane	212
Tronchetto tagliapizza	105
Vaporizzatori cocktail	180
Vaschetta lavaggio dosatori gelato	23-170
Vassoi	40-133-139-152-153-164-165
Versus	186-187
Wok antiaderente	35-37-39
Zuppiera	150

Adaptor bar for GN	84	Gastronorm drainer plate	84-87-88	Pizza wheel cutter	61-105
All-purpose scoop	49-125-183-194	Gastronorm polycarbonate	86-87	Pizzeria brushes	100-101
Apple corer	66	Gastronorm polypropylene	88	Planetary mixer	206
Ashtrays	171-185-191	Gastronorm stainless steel	82-83	Plastic box for dough	103
Asparagus peeler	67	Classes	174-192-193	Plastic cruets	185
Bain marie pot	49	Glass for boston shaker	173	Plastic grill for decorated biscuit	137
Baking beans	139	Glass rimmer	189	Plastic mask for decoration	137-138
Baking cases	124	Gloves	65-69	Plastic shell	155
Baking pan	52	Graduated bucket	51	Plate cover	151
Baking plate	52	Graters	62-64-71	Polycarbonate bowl	89-155
Bar mats	190	Ham vice	69	Polyethylene dispenser	192
Bar organizer	189	Hand held knife sharpener	77	Pourers	24→29-161→163
Baskets	149-156-194-195	Hanging bar	56-157	Protection mesh for bar	190
Belgian waffle makers	211	Hats	125	Rack for terrines	80-81
Beverage spoons	144-147-169	Heating liquid for chafing dish	155	Ring for mixing bowl	51
Biscuit cutter	120→124	Ice-breaker - electric	198	Roaster	40
Blades for vegetable slicer	70-71	Ice-breaker - manual	191	Roller cutter	119
Blender	200-201	Ice bucket	183	Safety guard	70
Boston shakers	172	Ice-cream cup	171	Salad servers	144-147
Bottle cap	170	Ice-cream container	23	Sauce ladle	144-147-151
Bottle-openers	170-182	Ice-cream sandwich press	210	Sauce-boat	150
Bottle stands	188	Ice-cream saucer	171	Saw	69
Bowl	50-51	Ice-cream scoop	20-21	Scissor servers	14-15-109
B-Pour pour check	28-161	Ice-cream scoop basin	23-170	Scrapers	61-105-118-119
Bread cutter	71	Ice-cream server	22	Semifreddo moulds	125
Butchery hooks	68	Immersion blender	202	Serving plates	150→152
Butter curler	66	Japanese egg pan	45	Shakers	172-174-175
Butter spreader	144-145	Jiggers	169-176-177	Shallow cookpots	34-36-38-40-44
Cake marker	114	Juice extractors	207	Shallow cookpot with non-stick coating	42
Cake mould	126-129→134	Kitchen bowl	49	Shallow saucepans	34-36
Cake slicer	139	Knife sharpener	207	Shellfish scissors	67
Cake stand	133-134-138	Knives	72→78	Sieves	50
Carafes	193	Ladles	53-55-56-58-144-157-168	Skewers	69
Carving and decoration set	77-163	Large spoon	53→58-144-145-147-157	Skimmers	53→58-65-157
Champagne bowl	179	Lemon peeler	66-163-170	Snail dish	154
Charcoal shovel	93-101	Lemon squeezer	170-181	Snail fork	147
Cherry ladles	168	Lids for pots and pans	35-37-38-41-45-46	Sofflex moulds	110-111
Chinois	48-50	Lid for gastronorm	84-87-88	Soup-tureen	150
Chopping block	69	Lifters	53-55-56-59-157	Spare parts for electrical accessories	199-205
Citrus fruit squeezer - electric	198-207	Lobster pick	147	Spatulas	60-61-104-116→118-134
Citrus fruit squeezer - manual	169	Long handle strainer	61	Speed bottle	187
Coaster	171	Measuring jug	49-125	Speed racks	180
Cocktail atomizer	180	Meat beater	68	Spice grinder	205
Cocktail strainer	169-173	Meat fork	53-55→57-65-144-145-157	Spirits measure	188
Cocoa sprinkler	166	Medium cookpots	34-36-38-40-44-46	Stand for bucket	183
Coffee jug	166	Medium cookpot with non-stick coating	42	Steady Spout	29-162
Coffee tamper	166	Medium saucepans	34-36-38-40-44-46	Stirring spoon	169
Compact panini grill	203	Melon baller	62-161	Stopper for cutting boards	79
Condiment set	148	Milk jug	166	Storplus containers	89
Convection oven	212	Mixers	198-203→205	Strainer for deep cookpot	48
Cream jug	166	Mixing glasses	174	Strainers	30-65
Croissant roller cutter	119	Mixing spoon	180-181	Straws	197
Cruets	184-188	Moka spoon	142→145	Sugar bowl	194
Crumb sweepers	154-185	Moka spoon holder	170	Support for pastry bag	112
Curved saute pans	35-37-45	"Mollunga" tongs	13	Support for strainer filler	134
Cutting boards	79-189	Mugs	178-179	Syphons	184
Dash bottles	180	Multipurpose decorator	67	Vegetable peeler	67
Decorating nozzles	113→115	Napkin-holder	171-184-194	Table-cloth fixer	170
Deep cookpots	34-36-38-40-44-46	Non-stick baking mat - fiberlux	136	Table fork	142→145
Deep cookpot with non-stick coating	42	Nozzles brush	115	Table knife	142→145
Deep fryer	209	Olive stoner	67	Table spoon	142→145
Deep saucepans	34-36-38-41-44-46	Orange peeler	62-161	Tea infuser	171
Display tray	70	Order rack	185	Teapot	166
Doyleys	124	Oven brushes	93-100-101	Thermal circulator	208
Egg cup	154	Oven rake	93-101	Thermometers	64
Egg frying pan	154	Oyster fork	147	Toaster	212
Egg slicer	67	Oyster opener	78	Tongs	12→17-32-108-160
Electric heater for Chafing Dish	155	Panini grill	209	Toothpicks holder	148-154
Electric ice-cream maker	206	Pans	35-37-38-41	Trays	40-133-139-152-153-164-165
Falling handles for GN	84	Parmesan cheese cellar	148	Tray rest	194
Firedog	103	Pasta strainer	51	Truffle-slicer	155
Fish-bone tray	154	Pasta warmer	48	Two-handed frying pans	35-37-39-41-45-46
Fish lifter	53-54	Pastry bags	112-114	Two-handed frying pan non-stick coating	42
Fish scaler	67	Pastry brush	119	Under plate	149
Flair bottle	190	Pastry comb for decoration	120	Vacuum sealing system	207
Flat rack	125-134	Pastry cutter	61-104-105-116-118-120→123	Vegetable dish	150
Flexible desk cleaner	104	Pastry moulds	125→134-139	Vegetable slicers	70-71
Food carrier	70	Pastry wheel cutter	118	Versus	186-187
Food dehydrator	208	Pestles	189-196	Waffle cone maker	210
Food processors	204-205	Pie mould	49	Wall mounted peel rack	103
Frame for biscuit	135	Pie server	143→146	Wall rack for pastry bags	112
Frying pans	35-37-38-41-45-46	Pizza boards	98	Whisks	64
Frying pans with non-stick coating	35-37-39-41-45	Pizza cutter	105	Wine buckets	179
Funnel	134	Pizza peels and turning peels	93→99-101	Wok with non-stick coating	35-37-39
Gastronorm baking pan	83	Pizza peels and turning peels Gluten Free	102		

SUPPORTO VENDITA

SALES SUPPORT ITEMS

Cod. X0100
CATALOGO PIAZZA
 PIAZZA CATALOGUE

Cod. X0101
LISTINO PIAZZA (PDF)
 PIAZZA PRICE LIST (PDF)

Cod. X0118
CATALOGO PIAZZA-ATLANTIC CHEF (PDF)
 PIAZZA-ATLANTIC CHEF CATALOGUE (PDF)

Cod. X0119
CATALOGO PIZZERIA COLLEZ. PUNTOROSSO (PDF)
 PIZZERIA CATALOGUE PUNTOROSSO COLLEC. (PDF)

Cod. X0239
VOLANTINO PENTOLE COLLEZIONE "CHEF" (PDF)
 POTS AND PANS 'CHEF' COLLECTION' LEAFLET (PDF)

Cod. X0246
VOLANTINO PENTOLE ALLUMINIO (PDF)
 ALUMINUM POTS AND PANS LEAFLET (PDF)

Cod. X0247
VOLANTINO GRATTOGIE PROFESSIONALI (PDF)
 PROFESSIONAL GRATER LEAFLET (PDF)

Cod. X0248
VOLANTINO MOLLE NYLON+FIBERGLASS (PDF)
 NYLON+FIBERGLASS TONGS LEAFLET (PDF)

Cod. X0249
VOLANT. MESTOLAME NYLON+FIBERGLASS (PDF)
 NYLON+FIBERGLASS KITCHEN TOOLS LEAFLET (PDF)

Cod. X0250
BROCHURE "UNA STORIA DI QUALITÀ" (PDF)
 'HISTORY OF QUALITY' BROCHURE (PDF)

Cod. X0330
CATALOGO HAPPY HOUR (PDF)
 HAPPY HOUR CATALOGUE (PDF)

Cod. X0344
BROCHURE COLLEZIONE MOLLE (PDF)
 TONGS COLLECTION BROCHURE (PDF)

Cod. X0345
DEPLIANT STEADY SPOUT 2.0 (PDF)
 STEADY SPOUT 2.0 BROCHURE (PDF)

Cod. X0347
DEPLIANT NUOVO PORZIONATORE (PDF)
 NEW ICE-CREAM SCOOP BROCHURE (PDF)

Cod. X0348
DEPLIANT NUOVA "5 STELLE" (PDF)
 NEW '5 STARS' BROCHURE (PDF)

Cod. X0349
DEPLIANT PENTOLE COLLEZIONE "3-PLY" (PDF)
 POTS AND PANS '3-PLY' COLLECTION' LEAFLET (PDF)

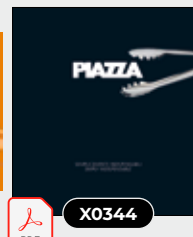
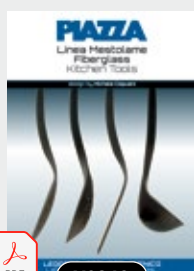
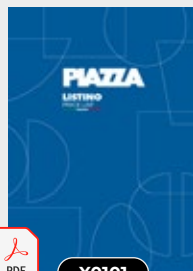

 **QUESTO SIMBOLO INDICA CHE I MATERIALI SONO DISPONIBILI SOLO IN FORMATO DIGITALE (FILE PDF)**
 THIS SYMBOL INDICATES THAT THE MATERIALS ARE AVAILABLE ONLY IN DIGITAL FORM (PDF FILE)

SCOPRI IL NOSTRO SITO
 DISCOVER OUR WEBSITE

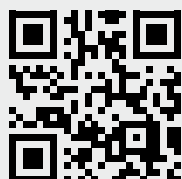

SFOGLIA IL NOSTRO CATALOGO
 BROWSE OUR CATALOGUE



TABELLE CONVERSIONE

CONVERSION TABLES

LUNGHEZZA LENGTH

0,30	1	3.28
0,61	2	6.56
0,91	3	9.84
1,22	4	13.12
2,52	5	16.40
1,83	6	19.68
2,13	7	22.96
2,44	8	26.25
2,74	9	29.53
3,05	10	32.81
6,10	20	65.62
15,24	50	164.05
30,50	100	328.10

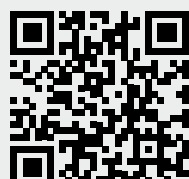
METRI
METERS

PIEDI
FEET

2,54	1	0.39
5,08	2	0.79
7,62	3	1.18
10,16	4	1.58
12,70	5	1.97
15,24	6	2.36
17,78	7	2.80
20,32	8	3.16
22,86	9	3.55
25,40	10	3.94
50,80	20	7.88
127,00	50	19.70
254,00	100	39.40

CENTIMETRI
CENTIMETERS

POLLICI
INCHES

PESO WEIGHT

28,3	1	0.04
56,7	2	0.07
85,0	3	0.10
113,4	4	0.14
141,8	5	0.18
170,1	6	0.21
198,4	7	0.25
226,8	8	0.28
255,2	9	0.32
283,5	10	0.35
567,0	20	0.71
1417,5	50	1.76
2835,0	100	3.53

GRAMMI
GRAMS

ONCE
OUNCES

0,45	1	2.21
0,91	2	4.41
1,36	3	6.62
1,81	4	8.82
2,27	5	11.02
2,72	6	13.23
3,18	7	15.43
3,63	8	17.64
4,09	9	19.84
4,54	10	22.05
9,07	20	44.09
22,68	50	110.20
45,36	100	220.50

CHILOGRAMMI
KILOGRAMS

LIBBRE
POUNDS

CAPACITÀ CAPACITY

3,79	1	0.26
7,57	2	0.53
11,35	3	0.79
15,14	4	1.06
18,93	5	1.32
22,71	6	1.58
26,50	7	1.85
30,28	8	2.11
34,16	9	2.38
37,94	10	2.64
75,88	20	5.28
189,70	50	13.20
379,40	100	26.40

LITRI
LITERS

GALLONI USA
USA GALS

1,50	0,5	0.16
2,25	0,75	0.25
3,00	1	0.33
4,50	1,5	0.50
6,00	2	0.66
7,50	2,5	0.83
9,00	3	1.00
10,50	3,5	1.16
12,00	4	1.33
13,50	4,5	1.50
15,00	5	1.66
16,50	5,5	1.83
18,00	6	2.00

CENTILITRI
CENTILITERS

ONCE
OZS

TEMPERATURA TEMPERATURE

-40,0	-40	-40.0
-28,8	-20	-4.0
-23,3	-10	+14.0
-17,7	0	+32.0
-12,2	10	+50.0
-6,6	20	+68.0
+2,7	37	+98.6
+4,4	40	+104.0
+10,0	50	+122.0
+37,7	100	+212.0

CELSIUS

FAHRENHEIT

PIAZZA

PIAZZA EFFEPI s.r.l.

Sede Legale

Corso Buenos Aires, 64 Scala D
20124 Milano (MI) - ITALY

Sede Operativa

via Fratelli Cairoli, 1
28887 Omegna (VB) - ITALY
Tel. +39 0323 6605 r.a.
Mail. piazza@piazza.it
Web. www.piazza.it

